

The importance of middlings in the beneficiation technology of Polish copper ore and new possibilities of their processing

Bożena Skorupska^{1,*}, Andrzej Wieniewski¹, and Norbert Kubacz¹

¹Institute of Non-ferrous Metals, ul. Sowinskiego 5, 44-100 Gliwice, Poland

Abstract. In the paper, the middlings (tailings of I cleaner flotation) were characterized, and new possibilities of their processing were presented. The advantages of introducing a separate circuit for middlings processing were emphasized. This circuit should be adapted to the properties of the processed middlings and characterized by relative simplicity. An important element of the separate processing of middlings is grinding. The paper presents the advantages of the grinding process in the magnetic mill (MM), which has not been used until now in the enrichment of mineral raw materials. The importance of introducing for the difficult to treat middlings a separate flotation in a flotation machine characterized by a high dynamics of the process was emphasized.

1 Introduction

One of the reasons for technological problems of copper ore enrichment at KGHM PM SA are circulating in the system so called middlings. They arise as a result of cleaning the concentrates, as tailings of I cleaning operation. The diagram of middlings formation is shown in Figure 1. The scale of the problems posed by the middlings is high due to their poor enrichability. The high content of copper in the middlings does not allow them to be sent to tailings, but it is too low to be a component of the final concentrate. As a result, how much of copper obtained from the middlings will be directed to the concentrate and how much to tailings depends on the technology of middlings processing used and the quality requirements for the final concentrate.

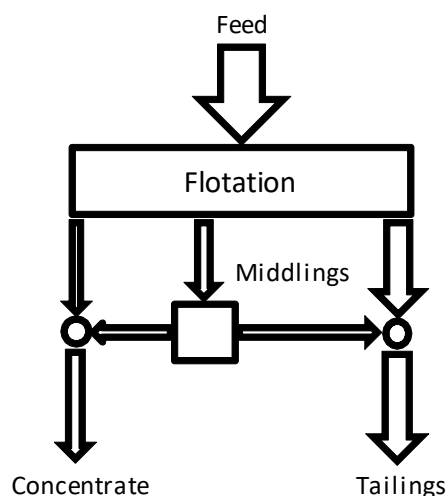

Fig. 1. The basic diagram for the division of the middlings into concentrate and tailings.

* Corresponding author: bozenas@imm.gliwice.pl

In recent years, in all enrichment plants, despite the decrease in copper content in the ore directed to the enrichment, the copper content in the middlings increased. This is due to a change in the enrichability of the processed ore resulting from an increased share of the difficult to treat shale fraction in the extracted ore. This fraction is a carrier of large quantity of organic matter which influences negatively on the flotation process. The increased amount of shale in the processed ore results in yield increase of froth product in the rougher flotation, thereby increasing the circulating amount of middlings. It negatively affects the enrichment process and causes an increase of metal losses in tailings.

At present (2015), it is estimated that in the middlings circulates around 70 to over 80% of mass of ore carrying about 180 to over 200% of copper, which occurs mainly in the form of unliberated copper sulphides. An additional problem is the accumulation of organic carbon – the middlings contain it between tens and hundreds of percent.

Efforts should be made to reduce the amount of middlings by improving their floatability. This task is not easy and has not yet been resolved in a satisfactory way. It should be emphasized that the kind of ore determines the scale of problems posed by middlings.

Therefore, in most enrichment plants in the world, in the case of processing the easy to treat porphyry ores, the problem of middlings is of less importance and the existing method for their processing is satisfactory.

The problem of middlings is usually solved in two ways. One is to return the middlings to the front of the rougher flotation, where together with the new batch of ore is subjected to flotation. In some cases, the middlings are subjected, before they are directed to the front of flotation, to classification and regrinding. The second solution is to regrind the entire middlings with the

subsequent flotation until the final tailings are obtained. Each method has its own positive and negative sides.

In the case of the easy to treat porphyry ores, it is preferable to return the middlings to the front of flotation. A necessary condition is a low yield of froth product so that the amount of circulating middlings is low.

This condition is not met for ores with clay content and/or containing gangue components of good floatability (e.g. organic matter). In this case, the amount of circulating middlings is excessively increasing, and what is more, the unwanted ore components accumulate in them in large quantities.

Therefore, in the case of processing the domestic copper ores, the quantity and quality of the circulating middlings justify their separate processing with the separation of the second component of the final tailings. The separation of the middlings stream will facilitate the selection of the most advantageous conditions for their enrichment and the maintenance of the technological regime of processing.

The additional benefit of separate processing of middlings would also be the improvement of operating conditions of the rougher flotation, which feed would be deprived of the difficult to treat fraction derived from middlings.

2 Description of middlings and their current processing

Middlings are characterized by significantly poorer enrichability than raw ore. The main cause is the fine graining of useful minerals and the presence of organic matter that promotes good floatability of the waste rock. The fine particle size distribution of copper sulphide minerals causes that most of the mineral grains are present in unliberated form.

The chemical characteristics of middlings produced in all enrichment plants are shown below, while Table 1 shows the basic granulometric and mineralogical characteristics of the middlings originating from the Rudna Concentrator (2015).

Rudna Concentrator

- sandstone middlings – Cu about 13%; C_{org} about 5%

- carbonate middlings – Cu about 6%; C_{org} about 6%

Polkowice Concentrator

- middlings from II technological line – Cu about 6%; C_{org} about 8%

Lubin Concentrator

- middlings from I technological line – Cu 2.3%; C_{org} 9.8%

Current processing of middlings consists in their regrinding in mills with cyppebs as grinding media, then classification in hydrocyclones and return to the rougher flotation. Recirculation of middlings causes the overgrinding of copper sulphides and their accumulation in circuits. This also applies to other unfavourable ore constituents, including organic carbon, clay minerals, etc. This negatively affects the operation of the rougher flotation and the achieved final indexes of the enrichment process.

Another solution for the processing of middlings was applied at the Polkowice Concentrator. It consists in changing the enrichability of the floated middlings by chemical treatment - partial leaching of the gangue components from the intergrowths (chemical grinding). This process involves the liberation of fine copper sulphides, [1, 6].

As a result of the chemical modification of the middlings from the enrichment of carbonate copper ores process at the Polkowice Concentrator, the recovery of copper in the concentrate was increased by 2.60% and Cu content by about 1.50%, [2].

3 Technology of separate processing of middlings

In the case of domestic enrichment plants, both the mass and the amount of circulating copper justify a separate middlings processing circuit. On the one hand, its task would be to improve the enrichability of the middlings (e.g. through better liberation of useful minerals) and, on the other, an effective flotation. The middlings processing circuit should be tailored to the properties of the processed middlings and characterized by relative simplicity.

Table 1. Particle size distribution, chemical composition and the degree of liberation of sulphide minerals in the middlings at the Rudna Concentrator (QEMSCAN® analysis).

Grain class [mm]	Sandstone fraction			Carbonate fraction		
	Yield [%]	Cu [%]	Liberation degree*	Yield [%]	Cu [%]	Liberation degree*
0.2-0.1	35.51	16.41	18.94	22.93	5.42	4.40
0.1-0.075	18.43	16.30	9.50	14.14	4.51	6.05
0.075-0.045	17.80	12.69	6.49	20.09	3.24	8.71
0.045-0.036	3.97	13.76	1.80	5.06	3.51	2.61
0-0.036	24.29	9.53	8.51	37.78	2.89	15.80
Sum	100.00	13.6	45.25	100.00	6.20	37.55

* - degree of liberation of copper sulphide minerals 80-100%

Essential components of middlings processing (Fig. 2):

- regrinding in mills of special construction (Vertimill®, Isamill™ or other grinding mills which ensure fine grinding such as magnetic mills)
- separate flotation in a flotation machine with a limited chamber size (not more than 10-15m³) operating in dynamic conditions; flotation is preferably preceded by intensive conditioning of the middlings (HIC), [3].
 - maintaining an optimal technological regime (set of reagents, flotation density, etc.)
- directing the concentrate from the middlings processing circuit to the cleaner flotation and the tailings to the final tailings.

Due to the fact that significant amounts of copper sulphides in middlings are present in unliberated form, effective regrinding is an important issue.

This task is well met, for instance, by mills of special construction (Vertimill® or IsaMill™), which allow to obtain fine grain composition, usually below 75µm, with less energy consumption by about 30% than in conventional tumbling mills, [4]. In recent years on Polish market has appeared innovative technology of fine grinding in magnetic mill, [5].

The Institute of Non-ferrous Metals has a laboratory stand equipped with a magnetic flow mill. The mill's operating chamber is stationary, while the grinding operation is performed by very small grinding media that move with great intensity under variable magnetic field. The field is generated by a coil winding on the body of the mill chamber. This mill has successfully passed the laboratory tests in the range of grinding of middlings.

The mill is currently under construction on a semi-technical scale. A pilot plant for the flotation in a closed circuit will be equipped with this mill.

The parameters of the mill on semi-technical scale (Figure 3):

- dimensions of the working chamber 100x150 mm
- induction 90-120 mT
- active power 5 kW
- power supply 3x12 A
- frequency 50 Hz
- size of ferromagnetic grinding media 0.1x1 mm
- number of grinding media approx. 10% of chamber volume.

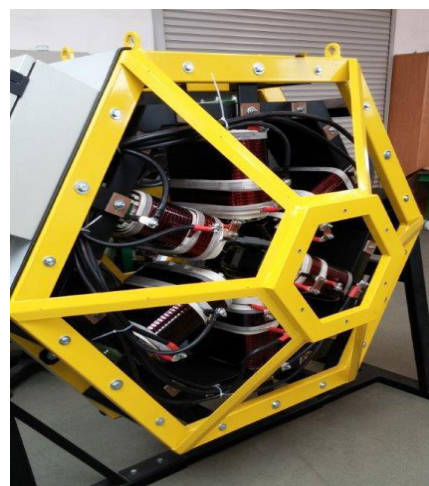

Fig. 3. Magnetic mill produced by Eltraf, Lubliniec.

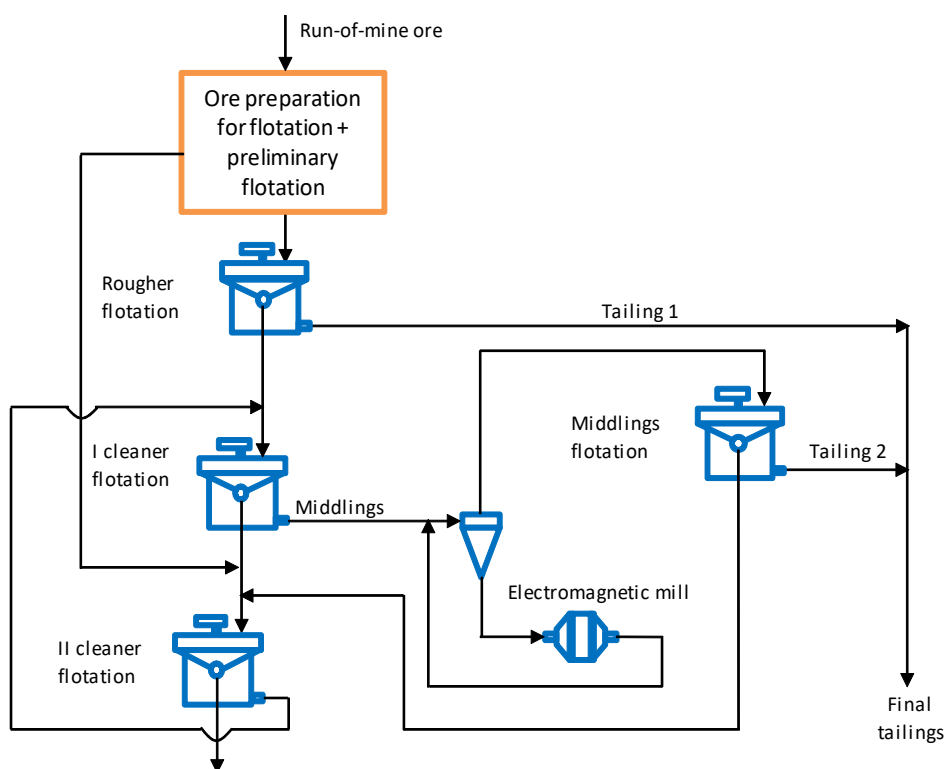

Fig. 2. Flowsheet of middlings processing.

3.1 Middlings regrinding

Carried out tests of fine grinding in a magnetic mill on a laboratory stand showed that the mill was characterized by high grinding intensity.

Grinding tests of middlings were performed:

- in a laboratory ball mill (BM) with an operation chamber volume of 2.6 dm³ to determine the kinetics of the middlings grinding; durations of grinding were - 5, 10, 15, 20 min; mass of grinding media - about 5.9 kg
- in an electromagnetic mill (MM), the suspension of 1 dm³ of about 1200 g. A grinding chamber volume of 0.76 dm³. Suspension flow - 2, 4 and 7 dm³/min; Weight of grinding media - 425 g.

Analyses of particle size distribution of the feed and grinding products are presented in Tables 3 and 4. The following equation was used to describe the course of the grinding process:

$$\gamma(d, t) = \gamma(d, 0) \exp(-k t^m)$$

t - grinding time

k - grinding speed

m - parameter of distribution.

An example of the changes in percentage of the retained products of the analyzed grain classes in the case of a magnetic and ball mill, depending on the duration of grinding is shown in Figures 4 and 5.

An evaluation of the grinding process can be made on the basis of the determined parameter k called the grinding speed factor and m which is the distribution factor. The factors k and m are given under the figures.

Grinding time of the middlings in MM is very short - several dozen times shorter than in the conventional ball mill (BM). It limits the phenomenon of overgrinding of the mineral grains.

This is confirmed by the calculated grinding speed factors k for fine grains (below 25 μm and below 35 μm) which are lower for grinding in MM than for grinding in BM.

Table 3. Results of grinding of middlings from Rudna Concentrator in a ball mill.

Product	Grain class [mm]	Ball mill, regrinding time									
		no regrinding		5 min		10 min		15 min		20 min	
		γ [%]	$\Sigma\gamma$ [%]	γ [%]	$\Sigma\gamma$ [%]	γ [%]	$\Sigma\gamma$ [%]	γ [%]	$\Sigma\gamma$ [%]	γ [%]	$\Sigma\gamma$ [%]
Sandstones	+0.10	35.51	35.51	7.05	7.05	2.56	2.56	0.14	0.14	-	-
	0.10-0.075	18.43	53.94	10.59	17.64	2.92	5.48	1.04	1.18	0.55	0.55
	0.075-0.045	17.80	71.74	27.20	44.84	15.98	21.46	10.02	11.20	6.12	6.67
	0.045-0.036	3.97	75.71	2.16	47.00	3.84	25.30	5.16	16.36	3.62	10.29
	0.036-0.025	5.64	81.35	7.97	54.97	10.53	35.83	10.88	27.24	15.26	25.55
	0.025-0	18.65	100.00	43.03	98.00	62.17	98.00	72.56	100.00	76.45	102.00
	Σ	100.00		98.00		98.00		100.00		102.00	
Carbonates	+0.10	22.93	22.93	3.25	3.25	0.49	0.49	0.10	0.10	-	-
	0.10-0.075	14.14	37.07	7.49	10.73	2.62	3.11	0.90	1.00	0.78	0.78
	0.075-0.045	20.09	57.16	24.14	34.88	17.03	20.14	10.56	11.57	7.02	7.80
	0.045-0.036	5.06	62.22	4.63	39.51	6.91	27.05	4.47	16.03	3.24	11.04
	0.036-0.025	7.97	70.19	6.12	45.63	9.86	36.91	9.15	25.18	11.43	22.47
	0.025-0	29.81	100.00	49.37	95.00	63.09	100.00	74.82	100.00	79.53	102.00
	Σ	100.00		95.00		100.00		100.00		102.00	

Table 4. Results of grinding of middlings from Rudna Concentrator in magnetic mill.

Product	Grain class [mm]	Electromagnetic mill, feed flow							
		no regrinding		7 dm ³ /min		4 dm ³ /min		2 dm ³ /min	
		γ [%]	$\Sigma\gamma$ [%]	γ [%]	$\Sigma\gamma$ [%]	γ [%]	$\Sigma\gamma$ [%]	γ [%]	$\Sigma\gamma$ [%]
Sandstones	+0.10	35.51	35.51	13.83	13.83	8.22	8.22	4.19	4.19
	0.10-0.075	18.43	53.94	13.35	27.18	8.59	16.81	5.21	9.40
	0.075-0.045	17.80	71.74	21.42	48.60	18.60	35.41	14.32	23.72
	0.045-0.036	3.97	75.71	3.57	52.17	4.58	39.99	3.33	27.06
	0.036-0.025	5.64	81.35	6.98	59.15	8.21	48.20	10.37	37.43
	0.025-0	18.65	100.00	40.85	100.00	51.80	100.00	62.57	100.00
	Σ	100.00		100.00		100.00		100.00	
Carbonates	+0.10	22.93	22.93	10.03	10.03	6.31	6.31	3.07	3.07
	0.10-0.075	14.14	37.07	8.79	18.83	6.20	12.51	3.14	6.21
	0.075-0.045	20.09	57.16	19.90	38.73	15.41	27.93	8.88	15.09
	0.045-0.036	5.06	62.22	3.95	42.68	4.56	32.49	3.84	18.93
	0.036-0.025	7.97	70.19	8.93	51.61	10.37	42.86	9.66	28.59
	0.025-0	29.81	100.00	48.39	100.00	57.14	100.00	71.41	100.00
	Σ	100.00		100.00		100.00		100.00	

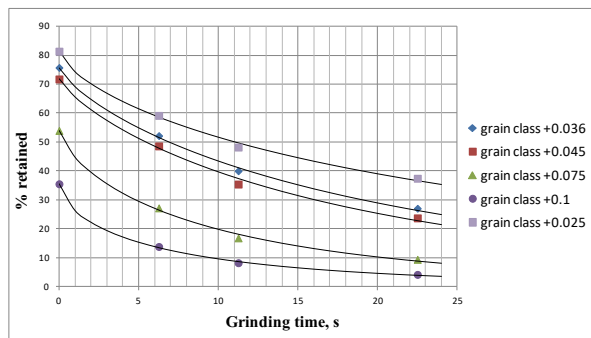

k – for grain class +0.025mm – 0.0924, m – 0.6924
 k – for grain class +0.036 mm – 0.0895, m – 0.7914
 k – for grain class +0.045mm – 0.0917, m – 0.8114
 k – for grain class +0.075mm – 0.1875, m – 0.727
 k – for grain class +0.1mm – 0.3002, m – 0.6367

Fig. 4. Grinding kinetics of ore of predominantly sandstone fraction from Rudna Concentrator in MM.

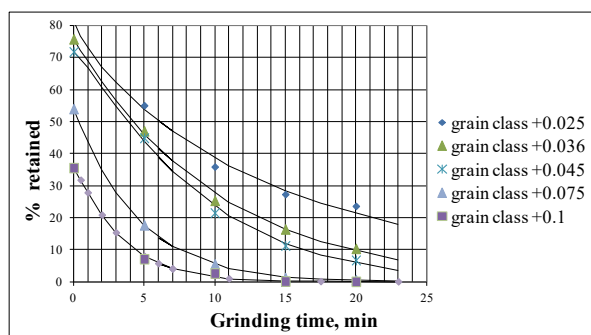

k – for grain class +0.025 mm – 0.106, m – 0.847
 k – for grain class +0.036 mm – 0.0943, m – 1.0308
 k – for grain class +0.045mm – 0.0735, m – 1.1813
 k – for grain class +0.075mm – 0.2089, m – 1.0463
 k – for grain class +0.1mm – 0.2451, m – 1.1223

Fig. 5. Grinding kinetics of ore of predominantly sandstone fraction from Rudna Concentrator in BM.

Mineralogical analyses of selected products after the grinding process in magnetic mill were performed using QEMSCAN® device. It is shown an exemplary mineralogical analysis result in which the share of copper in liberated sulphides was determined (degree of liberation 80-100%) after grinding time of about 6 and 11 seconds (Table 6). Large increase of liberated grains was observed in a short time as a result of grinding in MM. This mill can be a solution for future in the aspect of regrinding of middlings circulating in the enrichment circuits of non-ferrous metal ores.

Table 5. The share of copper in liberated Cu bearing minerals (QEMSCAN® analysis).

Mill	Grinding time	Cu [%]
MM	0 s	37.6
	6 s	55.4
	11 s	60.7

3.2 Influence of regrinding in magnetic field on flotation results

The effects of the middlings regrinding in MM on the results of flotation were investigated. The results of flotation of the reground in MM middlings were related to the results of flotation after grinding under standard conditions (in a ball mill).

As a result of grinding in BM (ball mill) and MM (magnetic mill) grain sizes d_{80} were as follows:

- grinding in BM

Middlings from Rudna Concentrator	Particle size of d_{80} product, μm					
	no regrinding	5 min	10 min	15 min	20 min	30 min
Sandstone fraction	144	71	47	34	32	30.4
Carbonate fraction	106	63	45	34	32	30.4

- grinding in MM

Middlings from Rudna Concentrator	Particle size of d_{80} product, μm			
	no regrinding	7 dm^3/min	4 dm^3/min	2 dm^3/min
Sandstone fraction	144	88	70	53
Carbonate fraction	106	73	60	36

Below the examples of flotation results are presented, obtained for middlings from the Rudna Concentrator, reground in BM and MM (Figures 6 and 7).

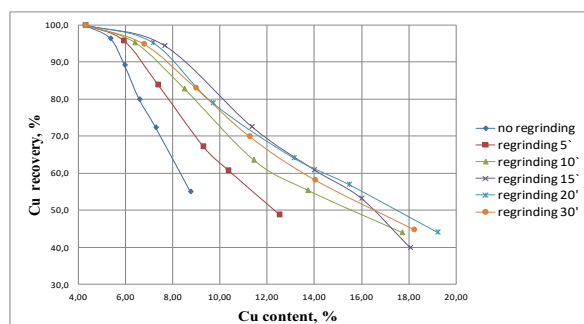

Fig. 6. Flotation results of the reground in BM carbonate middlings from Rudna Concentrator.

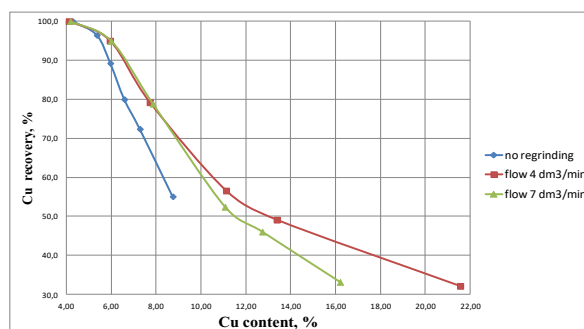

Fig. 7. Flotation results of the reground in MM carbonate middlings from Rudna Concentrator.

There was stated a positive effect of regrinding, both in the ball mill and the electromagnetic mill, on the results of the middlings flotation. There is a regrinding time limit and the associated degree of granulation of the tested middlings beyond which the flotation indexes are deteriorating.

On the basis of the flotation experiments optimum particle size (grain size d_{80}) was determined for the tested middlings to ensure a favourable copper recovery in the flotation process.

The flotation evaluation criterion was the quality of the concentrate (β) obtained for an equal recovery of 90%. It is presented for the middlings processed at the Rudna Concentrator as follows:

- carbonate circuit for particle size distribution determined by grain size $d_{80} = 34 \mu\text{m}$ - $\beta = 8\%$
- sandstone circuit for particle size distribution determined by grain size $d_{80} = 30 \mu\text{m}$ - $\beta = 24\%$.

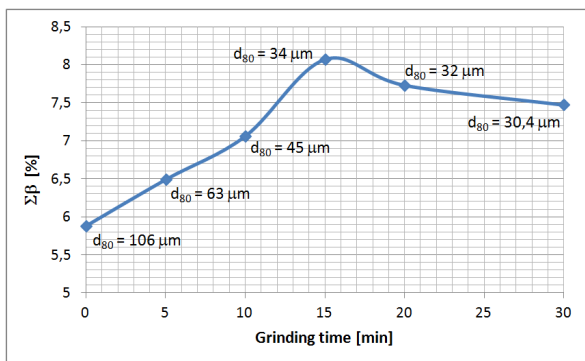

Fig. 8. Cu content in laboratory flotation concentrate as a function of grinding time and grain size d_{80} .

Figure 8 shows an exemplary copper recovery curve as a function of grinding time (d_{80}) for the carbonate middlings from the Rudna Concentrator.

The tests of regrinding and flotation of the middlings have confirmed the possibility and rightness of a separate middlings processing circuit including separate regrinding (e.g. in a magnetic mill) and the classification of I cleaner tailings in hydrocyclones followed by the flotation of these tailings (Figure 9).

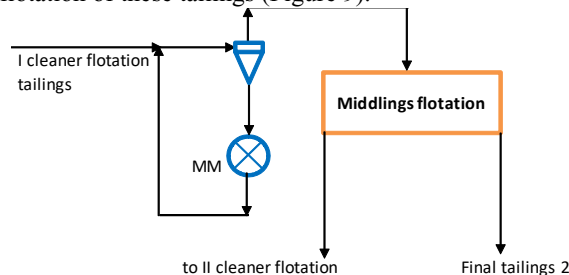

Fig. 9. The qualitative and quantitative diagram of the separate processing of the middlings at the Rudna Concentrator (carbonate circuit).

Another possible approach is flotation of only a hydrocyclone overflow carried out in the presence of depressant for organic carbon and regrinding of the hydrocyclone underflow returned to the main system (Figure 10).

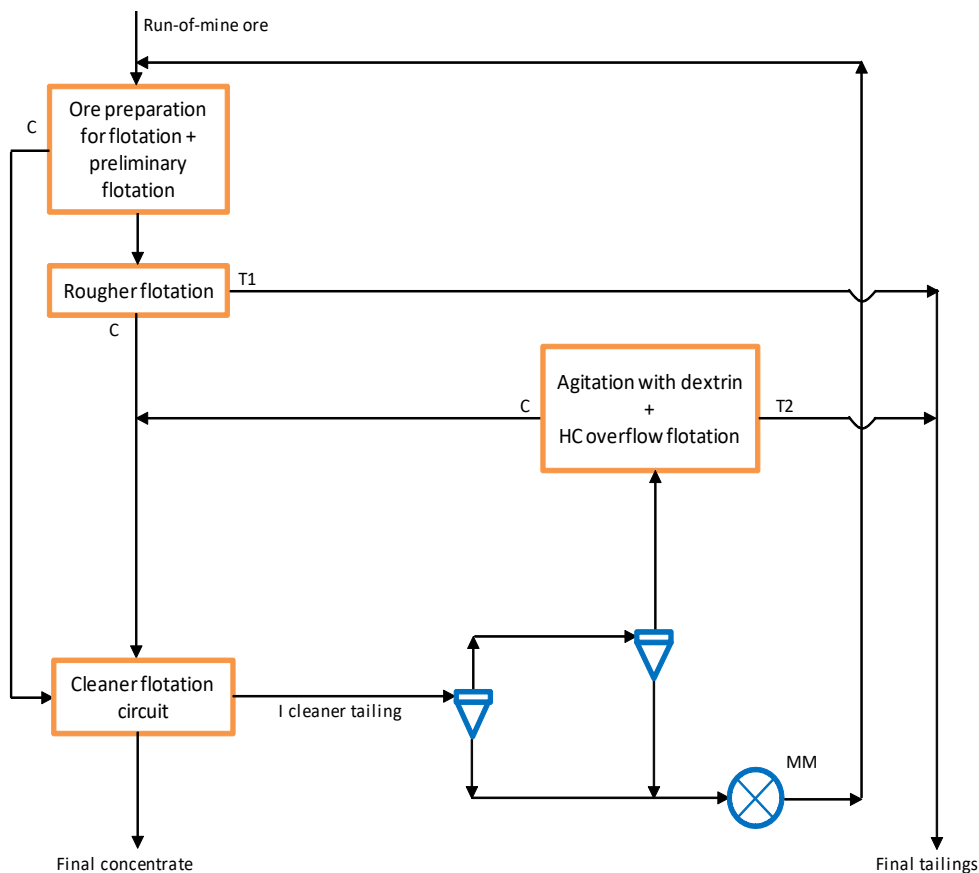

Fig. 10. Proposal of flowsheet for the production of concentrate with the reduced organic carbon content at the Rudna Concentrator (carbonate circuit).

4 Summary

Processing technology of middlings should be adapted to the mineral and petrographic properties of the processed ore. Therefore, in the case of Polish copper ores, which tend to produce large quantities of difficult to treat middlings, separate processing of these middlings should be preferred.

An important element of processing is to provide an optimal degree of granulation, which allows to obtain the most favourable flotation results. Comminution can be carried out using conventional grinding in tumbling mills, however, due to the required high degree of fineness, it would be advantageous to grind in mills designed for the fine grinding.

Among the well-known mills solutions for fine grinding worth noting is the construction of a magnetic mill that has existed on the Polish market for several years. The magnetic mill is characterized by high grinding intensity, so that the time of the grinding of the middlings is very short. This can have a positive effect on the granulation of the middlings, as the short grinding time limits the phenomenon of overgrinding of the grains.

Another important element of the middlings processing is flotation, which should be carried out under dynamic conditions, as this favours the fine grains flotation.

This approach will ensure better copper recovery from middlings and higher selectivity of the rougher flotation, which will contribute to the improvement of the index of copper recovery in the concentrate.

This article is based on the results of the project “Development of highly effective technology of Polish copper ore beneficiation” financed by KGHM PM SA and NCBiR.

References

1. T. Chmielewski, *Physicochem. Probl. Miner. Process.*, **41**, 337-348 (2007)
2. St. Sobierajski et al, *Opracowanie koncepcji technologii wzbogacania rud z wykorzystaniem metod chemiczno – flotacyjnych*, Report 6316/W/06
3. E. Tabosa, J. Rubio, *Minerals Engineering*, **23**(15), 1198-1206 (2010)
4. B.A Wills, T. Napier-Munn, *Mineral Processing Technology*, (2006)
5. T. Lokiec, H. Lokiec, *Wzbudnik mlyna elektromagnetycznego*, UP 412389, (2016)
6. A. Luszczkiewicz, T. Chmielewski, *Internat. J. Miner. Process.*, **88**(1-2), 45-52 (2008)