

# Investigations of hot water temperature changes at the pipe outflow

*Janusz Wojtkowiak*<sup>1,\*</sup>, and *Czesław Oleśkiewicz-Popiel*<sup>1</sup>

<sup>1</sup>Poznan University of Technology, Faculty of Civil and Environmental Engineering,  
ul. Berdychowo 4, 60-965 Poznan, Poland

**Abstract.** In this paper a process of cold water withdrawing from hot water supply pipe systems without recirculation is considered. System of partial differential equations was used to describe the pipe and water temperature changes. An exact solution of a simplified form of the equations was obtained and validated experimentally. The exact solution was applied to calculate the hot water temperature changes at the pipe outflow. Calculations were done for typical pipe materials (PP, PE, Cu), different pipe diameters and lengths as well as for various water flow rates. It was shown that in order to obtain the required hot water temperature in the tap, there is necessary to withdrawn much more (even two times) water from the pipe in comparison to the pipe volume. The reason of such significant water wastes is a heat exchange between hot water flowing inside the pipe and the colder pipe walls. The results can be useful for optimal selection of hot water supply pipes as well as for making decision about applying of hot water recirculating systems.

## 1 Introduction

Domestic hot water in supply pipes will cool due to heat loss when it will be stagnant for quite some time. In large domestic hot water systems, where the distribution piping is extensive, it will take a relatively long time to remove this cold water from the pipes before the hot water can be available at the tap. This wastes both water and energy are often not acceptable. To overcome this problem, a water recirculation system can be used. Unfortunately some of these systems are very wasteful. According to the regulation [1] the maximum internal volume of the hot water supply pipe for which recirculation system is not required is 3 dm<sup>3</sup>. The aim of this paper is to investigate the effect of pipe type as well as an influence of flow rate on hot water temperature changes at the pipe outflow. In particular, we are interested in time needed to obtain a required outflow water temperature and mass of water withdrawn from the pipe before the accepted temperature is reached.

---

\* Corresponding author: [janusz.wojtkowiak@put.poznan.pl](mailto:janusz.wojtkowiak@put.poznan.pl)

## 2 Theoretical model

Temperature changes of water ( $T_c$ ) and pipe ( $T_r$ ) are described in simplified form as [2]:

$$\tau_c \frac{\partial T_c}{\partial t} + \frac{1}{N_c} \frac{\partial T_c}{\partial z^*} = T_r - T_c \quad (1)$$

$$\tau_r \frac{\partial T_r}{\partial t} = T_c - T_r \quad (2)$$

with boundary conditions:

$$T_c|_{z=0} = T_0 + \Delta T \quad (3)$$

$$T_c|_{t=0} = T_0 \quad (4)$$

$$T_r|_{t=0} = T_0 \quad (5)$$

where:

$T_c$  [°C] – water temperature

$T_r$  [°C] – pipe temperature

$t$  [s] – time

$N_c$  [-] – number of heat transfer units

$z$  [m] – axial coordinate ( $z = 0$  at pipe inflow)

$z^* = z/L_r$  [-] – dimensionless axial coordinate

$L_r$  [m] – pipe length

$\tau_c$  [s] – time constant of water

$\tau_r$  [s] – time constant of pipe

$T_0$  [°C] – initial water and pipe temperature (cold water temperature)

$\Delta T = (T_1 - T_0)$  [°C] – hot and cold water temperature difference

$T_1$  [°C] – hot water temperature

In Eqs. (1) and (2), a lumped thermal capacity model [3] for pipe and assumption of uniform radial temperature distribution in water are used. The thermal insulation of the pipe is perfect. Functions  $N_c$ ,  $\tau_c$  i  $\tau_r$  were calculated as follows:

$$N_c = \frac{h_c A_r}{m c_c}, \quad \tau_c = \frac{m_c c_c}{h_c A_r}, \quad \tau_r = \frac{m_r c_r}{h_c A_r}$$

where:

$h_c$  [W/(m<sup>2</sup>K)] – heat transfer coefficient at the pipe surface

$A_r$  [m<sup>2</sup>] – pipe internal surface

$m$  [kg/s] – water flow rate

$c_c$  [J/(kg K)] – water specific heat

$m_r$  [kg] – pipe mass

$c_r$  [J/(kg K)] – pipe specific heat

$m_c$  [kg] – water mass in pipe

Heat transfer coefficient  $h_c$  was calculated using modified Nusselt equation [4] ( $Nu=0.024 Re^{0.786} Pr^{0.45} [1+2.4254/(L_r/d)^{0.676}]$ ). Transient temperature responses of water at the pipe outflow  $T_c = f(t, z = L_r)$  were obtained from exact analytical solution of Eqs. (1)–(5):

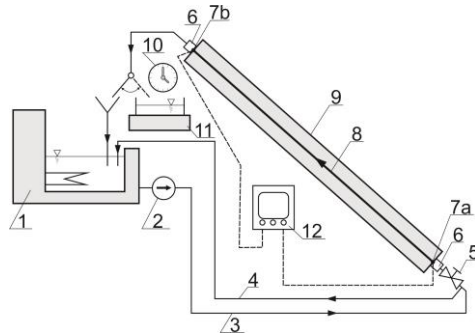
$$T_c = T_0 + \Delta T U(N_c, \eta) \exp[-(N_c + \eta)] \tag{6}$$

where:

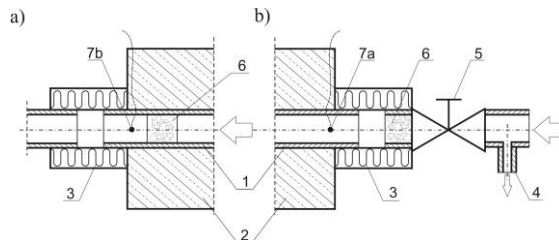
$$U(N_c, \eta) = \sum_{n=0}^{\infty} \sum_{k=0}^n \frac{\eta^n N_c^k}{n! k!}, \quad \eta = \frac{t - \tau_c / N_c}{\tau_r}$$

### 3 Model validation

An experimental validation of the theoretical calculation model was accomplished using the experimental set-up shown in Fig. 1. Details of the inlet and outlet of the investigated pipe are shown in Fig. 2. Length of the investigated copper pipe was  $L_r = 2.49$  m. Inner and outer diameters of the pipe were  $d_1 = 8.183$  mm and  $d_2 = 10.0$  mm. The flow rate was measured with the scales and stop watch. The inlet and outlet water temperatures were measured with the transient recorder. Initially in the insulated experimental pipe was cold water, i.e. the water taken from cold water supply pipe. The experimental run was started closing the recirculation hot water loop and opening the supply pipe hot water flow. During the hot water flow the outlet temperature was rising asymptotic until reaching the inlet hot water temperature. The whole temperature history was recorded with the 2 sec step.

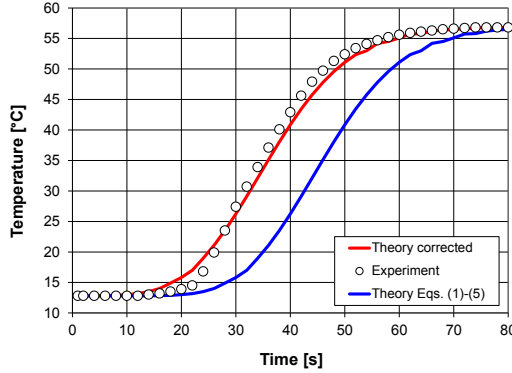


**Fig. 1.** Experimental set-up, 1 – thermostatic bath, 2 – circulation pump, 3 – supply pipe, 4 – recirculation pipe, 5 – stop and control valve, 6 – connector (thermal insulation), 7a – inflow temperature sensor, 7b – outflow temperature sensor, 8 – investigated pipe, 9 – thermal insulation, 10 – stop watch, 11 – scales, 12 – temperature transient recorder.

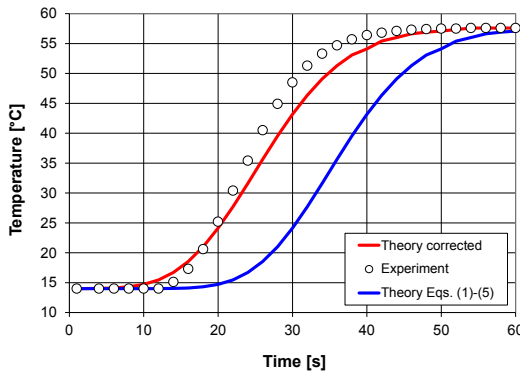


**Fig. 2.** Details of investigated pipe, 1 – investigated pipe, 2 – thermal insulation, 3 – connector (thermal insulation), 4 – recirculation tap, 5 – stop and control valve, 6 - mixer, 7a – inflow temperature sensor, 7b – outflow temperature sensor.

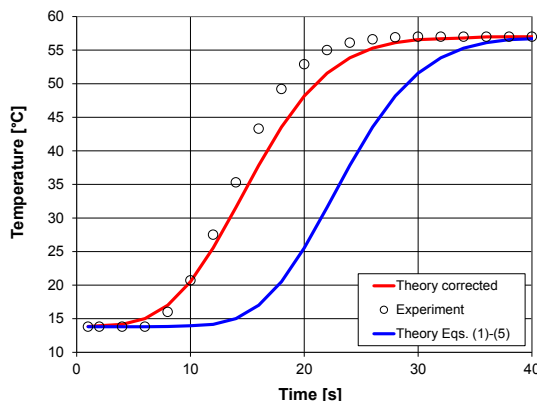
Comparison between theoretical and experimental results are shown in Figs. 3–5. As is seen, results obtained by means of Eqs. (1)–(5) are about  $\Delta t = 10 \pm 2$  s shifted in time (are retarded) in comparison with our experimental data.



**Fig. 3.** Comparison of experimental and theoretical results (copper pipe:  $d_1 = 8.183$  mm  $d_2 = 10$  mm,  $L_r = 2.49$  m,  $w = 0.166$  m/s,  $T_0 = 12.8^\circ\text{C}$ ,  $T_1 = 56.8^\circ\text{C}$ ,  $h_c = 1460$  W/(m<sup>2</sup>K)).



**Fig. 4.** Comparison of experimental and theoretical results (copper pipe:  $d_1 = 8.183$  mm  $d_2 = 10$  mm,  $L_r = 2.49$  m,  $w = 0.242$  m/s,  $T_0 = 14^\circ\text{C}$ ,  $T_1 = 57.6^\circ\text{C}$ ,  $h_c = 1960$  W/(m<sup>2</sup>K)).



**Fig. 5.** Comparison of experimental and theoretical results (copper pipe:  $d_1 = 8.183$  mm  $d_2 = 10$  mm,  $L_r = 2.49$  m,  $w = 0.435$  m/s,  $T_0 = 13.8^\circ\text{C}$ ,  $T_1 = 57.0^\circ\text{C}$ ,  $h_c = 3110$  W/(m<sup>2</sup>K)).

The differences are slightly higher at larger water velocities and their explanation can be found in simplified form of the theoretical model. Applying simple time correction in form of  $(t + \Delta t)$  to the theoretical results it can be obtained a quite good agreement between experimental and corrected theoretical results. Finally, i.e. after “shifting of time axis”, the discrepancies between dots and red lines shown in Figs. 3–5 were found as acceptable.

## 4 Calculation results

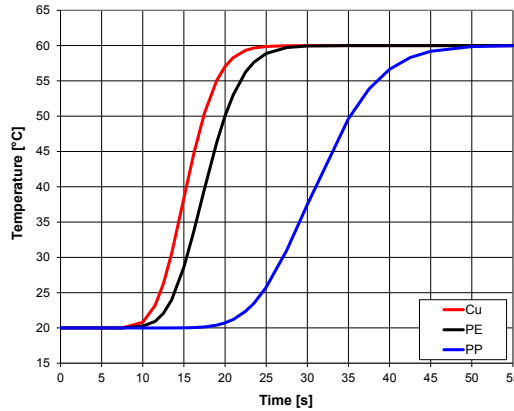
### 4.1 Effect of pipe type

A corrected theoretical model was applied for calculation of water outflow temperature changes for three standard commercial hot water supply pipes (Table 1).

**Table 1.** Considered pipes: Cu (copper), PE (polyethylene), PP (polypropylene).

Pipe	$d_1$ [mm]	$d_2$ [mm]	$L_r$ [m]	$A_r$ [m <sup>2</sup> ]	$\rho_r$ [kg/m <sup>3</sup> ]	$m_r$ [kg]	$c_r$ [J/(kgK)]	$Q_r$ [J]	$w$ [m/s]	$h_c$ [W/(m <sup>2</sup> K)]
Cu	13.0	15	22.6	0.9225	8800	8.743	380	132894	1.23	6150
PE	12.0	16	26.5	0.9797	1290	2.949	1620	190665	1.44	7180
PP	14.4	20	18.4	0.8139	905	2.463	2000	197040	1.00	5100

The pipe lengths  $L_r$  shown in Table 1 were obtained assuming that each pipe contains 3 dm<sup>3</sup> of water. According to the regulation [1], this is the maximum value. Symbols  $d_1$  and  $d_2$  mean inner and outer pipe diameters, respectively. The water velocities  $w$  were calculated for the flow rate 163 g/s in each pipe. The temperatures of cold and hot water were  $T_0 = 20^\circ\text{C}$  and  $T_1 = 60^\circ\text{C}$ . Pipe thermal capacity  $Q_r$  was calculated as  $Q_r = m_r c_r (T_1 - T_0)$ . Calculation results in form of outflow water temperature changes are presented in Fig. 6.



**Fig. 6.** Water temperature changes at the pipe outflow for 3 different pipes (Table 1) of identical internal volume (3 dm<sup>3</sup>), the same water flow rate (163 g/s), cold and hot temperatures 20°C and 60°C, respectively.

In Table 2 times  $t_{55}$  needed to obtain outflow water temperature of 55°C, and masses  $m_{55}$  of water withdrawing from the pipe until the water outflow temperature reaches 55°C are given.

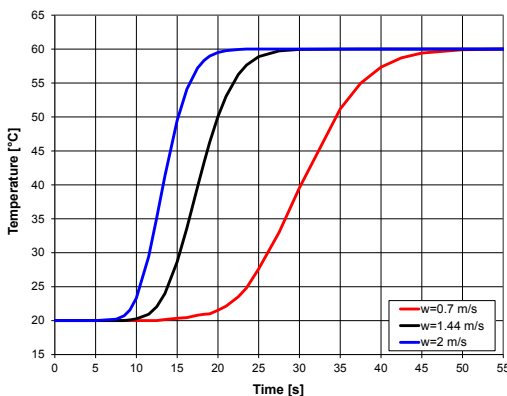
**Table 2.** Times  $t_{55}$  and masses  $m_{55}$  for different pipes (pipes data: see Table 1).

Pipe	$t_{55}$ [s]	$m_{55}$ [kg]
Cu	19.0	3.10
PE	22.4	3.64
PP	38.0	6.21

As one can see in Table 1, the PP pipe has the smallest internal surface  $A_i$ , the lowest heat transfer coefficient  $h_c$ , and the largest heat capacity  $Q_r$ . Therefore the intensity of heat exchange between water and PE pipe is smaller in comparison with the Cu and PE pipes. This is the most important cause of the discrepancies in temperature changes shown in Fig. 6. In Table 2 it is seen that for Cu pipe the smallest values of time  $t_{55}$  and mass  $m_{55}$  were obtained. For this pipe the mass  $m_{55} = 3,1$  kg is only a little bit larger than the initial mass of cold water in the pipe. Also for Cu pipe, the time  $t_{55} = 19$  s is only 1 s larger in comparison with time necessary to withdrawn the whole cold water from the pipe. For PP pipe, the  $m_{55}$  and  $t_{55}$  values are two time larger than for Cu pipe. For PE pipe,  $m_{55}$  and  $t_{55}$  reach intermediate values.

#### 4.2 Effect of water velocity

PE pipe (pipe data: see Table 1) was selected to present the effect of water velocity on outflow water temperature changes. The results are shown in Fig. 7 and Table 3.



**Fig. 7.** Water temperature changes at the PE pipe outflow (pipe data: see Table 1) for 3 different velocities:  $w = 0.7$  m/s and  $h_c = 4160$  W/(m<sup>2</sup> K),  $w = 1.44$  m/s and  $h_c = 7180$  W/(m<sup>2</sup> K),  $w = 2.0$  m/s and  $h_c = 9500$  W/(m<sup>2</sup> K).

**Table 3.** Times  $t_{55}$  and masses  $m_{55}$  for PE pipe (pipe data: see Table 1) and different water velocities.

$w$ [m/s]	$m$ [g/s]	$h_c$ [W/(m <sup>2</sup> K)]	$t_{55}$ [s]	$m_{55}$ [kg]
0.70	79	4160	37.5	2.97
1.44	163	7180	22.4	3.64
2.00	226	9500	17.3	3.85

As is seen, if water velocity increases, time necessary to reach an acceptable outflow temperature decreases and simultaneously mass of waste cold water increases.

## 5 Conclusions

The simply theoretical model was experimentally verified and introducing a time correction it was found useful for investigations of hot water temperature changes at the pipe outflow. The best hot water supply pipe should have small diameter and low thermal capacity value. Thermal insulation of the pipe ought to be as good as possible. An effect of the hot water flow rate on time needed to obtain a required outflow water temperature and the mass of cold water withdrawn from the pipe were investigated. It was found that with increasing of water velocity a decrease of time necessary to reach an acceptable outflow temperature and simultaneously an increase of losses of cold water are noticeable. The results can be applied for appropriate selection of hot water supply pipes, i.e. length, diameter and material. They can be also useful for making decision about applying of hot water recirculating systems.

## References

1. Dz. U. z dn. 17.07.2015, poz. 1422, § 120.1, (2015)
2. E.P. Sierov, B.P. Korolkov, *Dinamika parogieniatorov*. Energija, Moskva, **359–362** (1972)
3. J. Wojtkowiak, *Lumped Thermal Capacity Model* (In: *Encyclopedia of Thermal Stresses* Ed. R.B. Hetnarski, Springer, 2808–2817, 2014)
4. S. Kakac, R.K. Shah, W. Aung, *Handbook of Single-Phase Convective Heat Transfer* (Wiley, 4–33 & 4–58, 1987)