

# Design and Analysis of Controller with Selective Harmonic Compensator for Grid Connected PV System

M.Vasu<sup>1\*</sup>, D. Lenine<sup>2</sup>, J. Surya Kumari<sup>3</sup>, T. Suresh Kumar<sup>4</sup>

<sup>1</sup>Research Scholar, Department of EEE, JNTUA, A.P, India

<sup>2</sup>Professor, Department of EEE, RGM College of Engineering & Technology, Nandyal, A.P, India

<sup>3</sup>Associate Professor, Department of EEE, RGM College of Engineering & Technology, Nandyal, A.P, India

<sup>4</sup>Professor, Department of EEE, Gokarju Rangaraju Institute of Engineering & Technology, Hyderabad, India

**Abstract.** Harmonics produced by distributed power generation systems (DPGS) is a main power quality issue, particularly due to the number of these systems connected to the grid is always increasing. This means that, it is significant to control the harmonics caused by these inverters to limit their contrary effects on the grid power quality. This paper has proposed a new proportional current controller (P Resonant Current Controller) with selective harmonic compensator for grid connected photovoltaic (PV) systems. The proportional resonant current controller (PRCC) can have a significant effect on the quality of the current supplied to the grid by the PV inverter, and hence it is essential that the controller provides a high-quality sinusoidal output with negligible distortion to avoid generating harmonics. The effectiveness of the proposed framework has been verified using simulation results in MATLAB/Simulink.

**Keywords.** Distributed power generation system, MPPT, PV system, P-Resonant controller, Phase locked loop.

## 1. Introduction

Recently, due to environment pollution the distribution generation system using renewable energy sources like solar, wind power and micro-hydro power have become the main power generation systems. Solar powered electrical generation depend on photovoltaic (PV) system. PV system uses one or more solar panels to convert solar energy into electricity. The most collective way to produce solar energy is to conversion of photon energy to electrical energy. Now a day's photovoltaic system has greatly contribution to generate the electric power when it compares with the other renewable energy sources it has more abundance and sustainability [1].

Basically, PV system converts sun light into electricity by using photovoltaic modules. By using different maximum power point tracking [MPPT] techniques it is possible to extract the maximum power from photovoltaic modules [2]-[3]. The PV system generates DC, and it can be converted in to AC with desired frequency through inverter and it tied with grid is called Grid Tie inverter [GTI] [4-5]. Grid tie Normally, synchronization is required for grid tied inverter of the voltage such as fundamental frequency and phase must be unique to send power to the load. Harmonics generated by the distributed power generation system is

major power quality issue. It is very important to control the harmonics generated by these inverters to limit their adverse effects on the grid power quality [6].

## 2. Grid Connected System

Single phase grid connected configuration is shown in fig.1. The main elements that can be included in a system of photo voltaic conversion are the photo voltaic modules, dc link capacitor, Inverters, loads, utility grid.

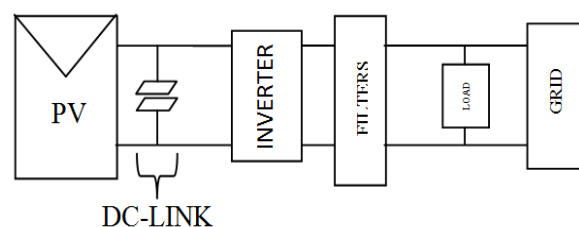

Fig.1. Single phase grid connected configuration.

The most common PV-technologies used nowadays are the single-crystalline silicon and the multi-crystalline silicon modules [8]. Power electronics has a significance role in the field of solar photovoltaic system. The enhancement of efficiency of the solar PV system is mainly depends on the power electronics-based devices

\*Corresponding Author: [vasumattukuru.eee@gmail.com](mailto:vasumattukuru.eee@gmail.com)

like converter and inverter. The conversion efficiency and losses have significantly reduced by the application of these devices.

### A. Modeling of PV system

Basically, solar cell is a p-n junction diode that directly converts light energy into electricity. The equivalent circuit of the general model which consists of a photon current, a diode, a parallel resistor and series resistor it express leakage current, an internal resistance to the current flow respectively as shown in Fig 2. The current source  $I_{ph}$  represents the cell photo current.  $R_{sh}$  and  $R_{se}$  are representing the intrinsic shunt and series resistance of the solar cell.

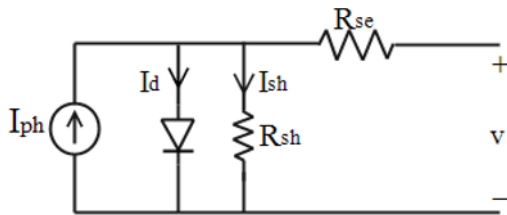

**Fig.2.** Equivalent circuit models of generalized PV

The basic equation is taken from theory of semiconductor [9], mathematically describes the I-V characteristic of the PV cell is,

$$I = I_{ph} - I_{sh} \left[ \exp \left( \frac{q(V + I R_s)}{k T_c A} \right) - 1 \right] \quad (1)$$

The current-voltage characteristic equation of a solar cell is given as

$$I = I_{ph} - I_s \left[ \left( \frac{q(V + I R_s)}{k T_c A} \right) - 1 \right] - \frac{(V + I R_s)}{R_{sh}} \quad (2)$$

Where,

Symbol	Meaning of the symbol
I	voltage-current characteristic equation of a solar cell
$I_{ph}$	a light-generated current or photocurrent
$I_s$	the cell saturation of dark current
Q	electron charge ( $1.6 \cdot 10^{-19}C$ )
K	Boltzmann's constant ( $1.38 \cdot 10^{-23}$ J/K)
$T_c$	the working temperature of the cell's
A	An ideal factor of the diode
$R_{sh}$	shunt resistance
$R_{se}$	Series resistance.

The ideal factor A is dependent on PV technology [10]. Photon current is mainly depending on the outer environment irradiance and temperature of the sunlight is represented as

$$I_{ph} = [I_{sc} + k_I(T_c - T_{ref})] \lambda \quad (3)$$

Where,

Symbol	Meaning of the symbol
$I_{sc}$	short-circuit current at a $25^\circ C$ and $1kW/m^2$
$k_I$	the cell's short circuit current temperature coefficient
$T_c$	the working temperature of the cell's
$T_{ref}$	cell's reference temperature,
$\lambda$	Solar insulation in $kW/m^2$ .

The cell's saturation current differs by the instant variation of the cell's temperature which is described as

$$I_s = I_{rs} \left( \frac{T_c}{T_{ref}} \right)^3 \exp \left( \frac{q E_G \left( \frac{1}{T_{ref}} - \frac{1}{T_c} \right)}{k A} \right) \quad (4)$$

Where,

Symbol	Meaning of the symbol
$I_{rs}$	cell's reverse saturation current at a reference temperature and a solar radiation
$E_G$	band-gap energy of the semiconductor used in the cell
$T_c$	the working temperature of the cell's
$T_{ref}$	cell's reference temperature
k	Boltzmann's constant ( $1.38 \cdot 10^{-23}$ ) J/K

### B. Selection of DC-LINK capacitor

The selection criteria of dc-link capacitor based on the optimal ac line current regulation strategy for the single-phase grid-connected photovoltaic (GCPV) system. The expression for dc-link capacitance can be derived as [11].

$$C = \frac{2 T_{ac} \Delta P (\alpha_{Max} - 1)}{V_{c, High}^2 - V_{c, Low}^2} \quad (5)$$

### C. Inverter

For processing the DC power generated from solar PV panels to obtain AC power, inverters are used. Inverters are classified into three broad types [12]. Single-phase full bridge inverter circuit is shown in fig.3.

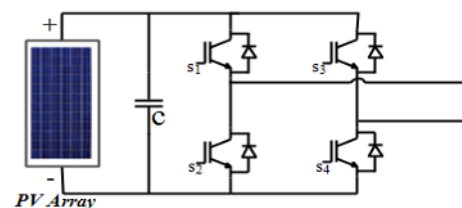

**Fig .3.** Circuit diagram of single-phase inverter

Grid-tied inverters are used where there is a provision to send the unused electrical energy to electrical board.

Grid-tied inverters are designed to provide up to 99% MPPT efficiency and after converting DC power to AC power it feeds the electricity into the grid system [13].

#### D. Filters

The L-filter is the first order filter with attenuation 20 dB/decade over the whole frequency range. The LC-filter is second order filter, and it has better damping manner than L-filter. This simple configuration is easy to design, and it works mostly without any problems. The second order filter provides 12 dB per octave of attenuation after the cut-off frequency of Transfer function of the LC-filter is,

$$G_f(s) = \frac{1}{1 + sL_f + s^2 * L_f * C_f} \quad (6)$$

The attenuation of the LCL-filter is 60 dB/decade for frequencies above resonant frequency, therefore lower switching frequency for the converter can be used. The LCL filter has good current ripple attenuation even with small inductance values.

### 3. Control Scheme for Grid-Connected Inverter

The main important elements of the PV System for control structure are: a maximum power point tracker (MPPT), a synchronization is obtain by using the phase-locked-loop (PLL), based on delay, the input power control using the dc voltage controller and power feed-forward, and the grid current controller implemented through a P- Resonant(PR) Control as shown in fig 4. The most common control structure for the dc-ac grid converter is a current-controlled H-bridge PWM inverter having a low-pass output filters. The drawback is its resonance frequency which can produce stability problems and special control design is required [15]. The control structure of the PV energy conversion system is shown in fig.4. The highly most elements of the control structure are the synchronization algorithm based on the MPPT, the input power control, PLL and the grid current controller.

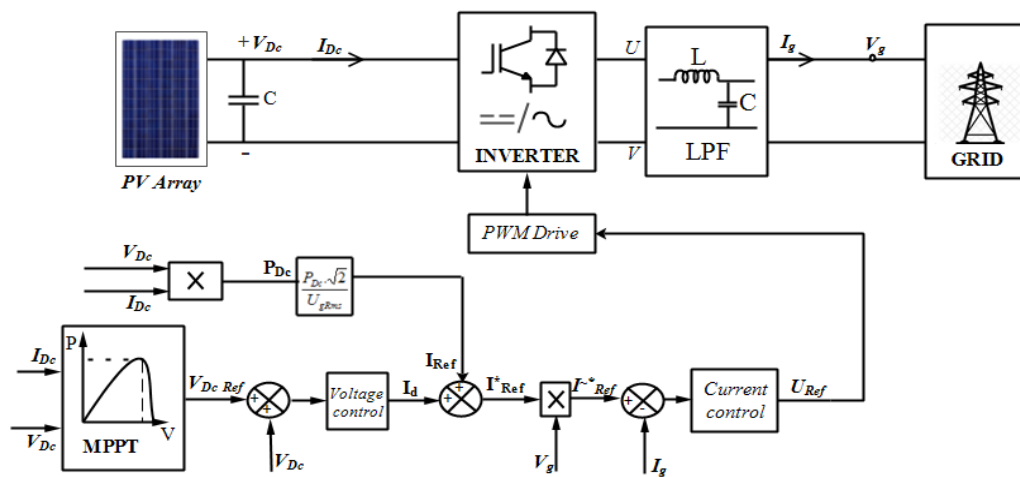

Fig.4. Control circuit for PV generation system

#### A. Phase locked loop

The phase locked loop (PLL) is used for bringing into a unity power factor operation which involves synchronization of the inverter output current with the grid voltage. The PLL structure is also used for grid voltage monitoring [15]. The general form of the PLL structure is presented in Fig.5.

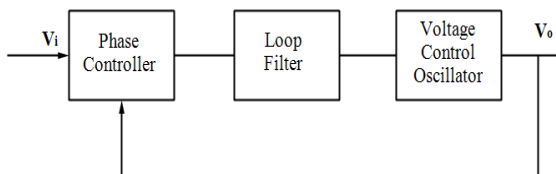

Fig. 5. Generalized structure of a 1-0 PLL

#### B. Perturbation and Observation Based MPPT Algorithm

The Perturbation and Observation (P&O) MPPT algorithm is easy to implement, it works based on the photovoltaic array which is perturbed of a radiation of orientation. If the power extraction from the array increases, the operating point varies towards the MPP which in turn suits therefore the working voltage in the similar direction.

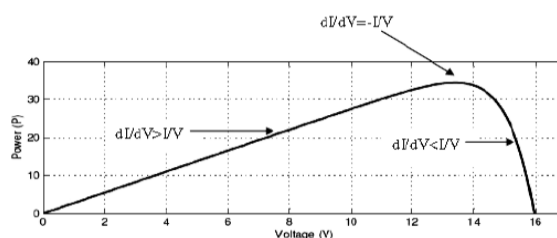

Fig. 6. P-V characteristics for P&O Algorithm.

#### C. Input Power Control

The control strategies of input power in the case of a power configuration of PV system without dc-dc

converter are presented in the following section. A new control strategy of input power is proposed in Fig.7. The new element introduced is the power feed-forward. The computed value of the current amplitude reference using the PV power ( $P_{DC}$ ) and the RMS value of the ac voltage ( $U_{g\_rms}$ ) is added to the output value of the dc voltage controller ( $I_d$ ) resulting in the ac current amplitude reference ( $I^*_{Ref}$ ). Using the input power feed-forward the dynamic of the PV system is improved being known the fact that the MPPT is rather slow. The dc voltage controller ensures a quick response of the PV system at a sudden change of the input power [16].

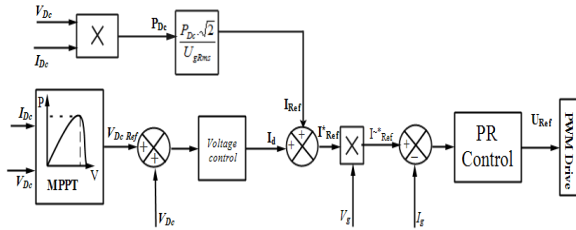

Fig. 7. Control circuit diagram for grid-connected PV system.

**D. Grid current controller**

Classical PI control with grid voltage feed-forward ( $U_g$ ) as depicted in fig.8 is commonly used for current-controlled PV inverters.

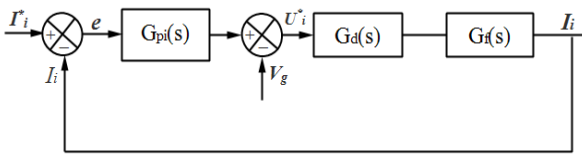

Fig. 8. PI Controller

$$G_{pi}(s) = K_p + \frac{K_i}{s} \tag{7}$$

Where,  $G_{pi}$  is Proportional Integral control,  $K_p$  is the Proportional gain,  $K_i$  is the Integral gain.

Alternative solution for the improperly performances of the PI controller is the PR controller. The current loop of the Photovoltaic inverter with PR controller is shown in Fig. 9.

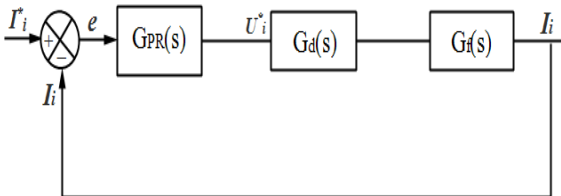

Fig. 9. PR controller

The PR current controller  $G_{PR}(s)$  is defined as [17], [19].

$$G_{PR}(s) = K_p + K_i \frac{s}{s^2 + \omega_o^2} \tag{8}$$

Where,  $K_p$  is the Proportional gain,  $K_i$  is the Integral gain

$\omega_o$  is the resonance frequency

$G_f(s)$  represent the low pass filters and  $G_d(s)$  represents the processing delay of the microcontroller, which is typically equal to the time of one sample  $T_s$  and is represented by

$$G_d(s) = \frac{1}{1 + sT_s} \tag{9}$$

An ideal PR control can give the stability problem because of the infinity gain to avoid the such problems the PR controller can be made non-ideal by introducing damping is given below

$$G_{PR}(s) = K_p + K_i \frac{s}{s^2 + 2\omega_c s + \omega_o^2} \tag{10}$$

Where,  $\omega_c$  is bandwidth around the ac frequency of  $\omega_o$

The PR controller with Harmonic Compensator (HC)  $G_H(s)$  as defined in [15]. PR+HC as shown in fig.10 PR+HC is suppressing the lower order add harmonic content.

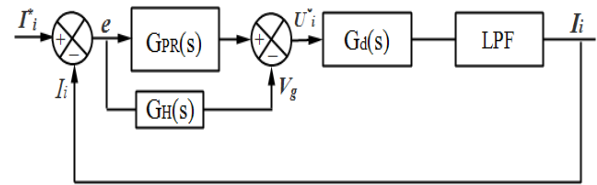

Fig. 10. PR Controller with Harmonic Component

$$G_H(s) = \sum_{H=3,5,7} K_{IH} \frac{s}{s^2 + (H\omega_o)^2} \tag{11}$$

Where,  $K_{IH}$  is the Resonant term at particular harmonic and  $H\omega_o$  is the resonant frequency of the particular harmonic.

To avoid the stability issues due to the instability gain, the harmonics compensators can be made non-ideal equation, as represented as

$$G_H(s) = \sum_{H=3,5,7} K_{IH} \frac{s}{s^2 + 2\omega_c s + (H\omega_o)^2} \tag{12}$$

Where,  $\omega_c$  is the bandwidth around the particular harmonic frequency of  $H\omega_o$ .

PR controller is implemented to reduce the selected harmonics 3<sup>rd</sup>, 5<sup>th</sup> and 7<sup>th</sup> as they are the most impact harmonics in the current spectrum. Although this controller has a high ability to track a sinusoidal reference such as a current wave form, the current of the grid tied inverter is not immune from the harmonic content (Zammitetal 2014) [19]. Harmonics in the output current can result due to the converter nonlinearities as well as from harmonics are already present in the grid. Selective harmonics in the output of the inverter current can be compensated by using additional PR controllers which act at particular harmonic frequencies to be

reduced such as the 3<sup>rd</sup>, 5<sup>th</sup>, 7<sup>th</sup>. This compensation can be used to reduce the current THD.

#### 4. Simulation Results

In this section, discussed about the system configurations and the performance of the single phase grid connected system is verified in MATLAB/SIMULINK at temperature 25 °c and irradiance 1000w / m<sup>2</sup>

**Table 1.** PV Solar Modules Specifications for STC

Parameter	Rating
Number of cells in series per module, n Cells	72
Parallel connected modules	3
series connected modules	10
Open circuit voltage, Voc	37.7 V
Short circuit current, Isc	8.66 A
Temperature coefficient of Voc	0.36901(% °C)
Temperature coefficient of Isc	0.086998(% °C)
Series resistance of PV model, Rs	0.23724Ω
Parallel resistance of PV model, Rp	224.1886Ω
Diode saturation current of PV model, Isat	4.1601e-6 A
Light-generated photo-current of PV model, Iph	8.7106 A
Diode quality factor of PV mode	1.019

**Table 2.** Single Phase Grid Specification

Parameter	Rating
Grid voltage	230 V (RMS)
Grid frequency	50 Hz
Grid resistance	0.001 Ω
Grid inductance	1mH

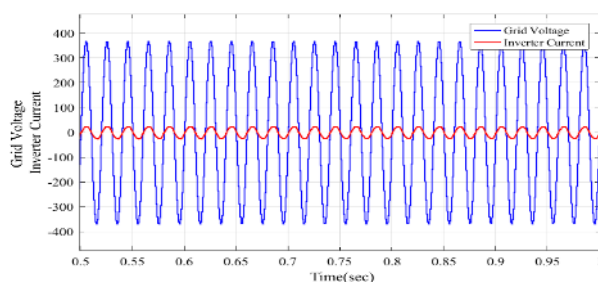

**Fig. 11.** Represent Grid Voltage and Inverter output current.

The PV array design specifications are shown in table I. Open circuit voltage and short circuit current of the solar modules are 37.7V and 8.66A respectively. Grid parameters are specified in table II. Fig.11. shows the grid voltage and inverter output current of the grid-connected system. Synchronization between grid voltage and current is obtained by using the PLL. The Vpcc is given to the PLL block to control the voltage and current

of the system. The harmonic analysis of the current is shown in fig.12. By using the P-resonant controller the total harmonic distortion is 11.82%. To reduce the current THD by adding the 3<sup>rd</sup>, 5<sup>th</sup> and 7<sup>th</sup> harmonic compensators to the p-resonant current controller. Fig.13 (a). shows the inverter output current by adding the different harmonic compensators to the P-resonant controller. Fig.13. (b) shows the THD analysis of the current with adding selective harmonic compensators to the resonant controller. By adding the different compensators, the THD value is reduced to 5.85%.

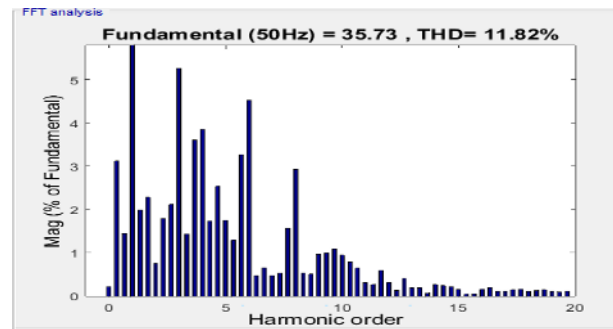

**Fig. 12.** THD analysis of current with PR Controller.

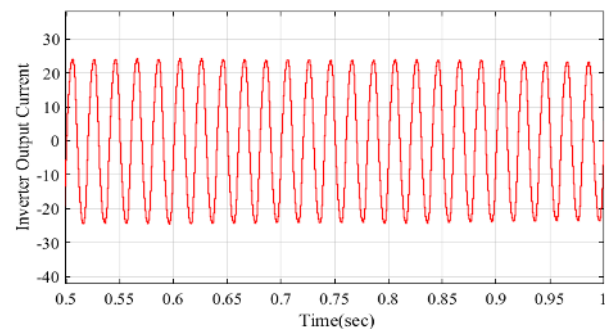

(a)

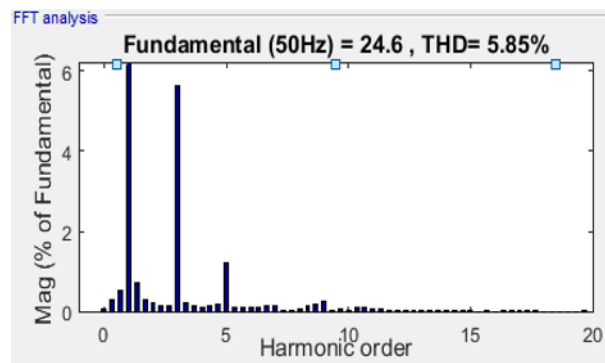

(b)

**Fig.13.** Simulation Results (a). Output current PR+ Additional Harmonics Compensator (b)Percentage of THD PR+ Additional Harmonics Compensator

#### 5. Conclusions

This paper presented a design of single-phase grid-connected PV system with proportional resonant controller. A complete analysis is passed out in order to estimate the effect of the PR current control

characteristics on the PV inverter performance. A set of design adjustments relating harmonic injection and grid synchronization. The design of PR current control and reduce the effective harmonics from inverter output current is done by using matlab/simulink. The design procedure is also formulated according to the IEEE standard requirement for grid interconnection.

## References

1. Abdalla Y. Mohammed, Farog L. Mohammed, Mamoun Y. Ibrahim, (ICCCCEE), Khartoum, Sudan, (2017).
2. Brito, M.A.G., Sampaio, L.P., Galotto Jr., L., Canesin, C.A.: IEEE Transactions on Industrial Electronics, **60** (3), 1156-1167, (2013)
3. Piegari, L., Rizzo, R.: IET Renewable Power Generation, **4** (4), 317-328 (2010)
4. R. Teodorescu, M. Liserre and P. Rodríguez, *Grid Converters for Photovoltaic and Wind Power Systems*, John Wiley & Sons, Ltd., 2011.
5. CIGRE Working Group B5.34, *The Impact of Renewable Energy Sources and Distributed Generation on Substation Protection and Automation* CIGRE, (2010).
6. Daniel Zammit, Cyril Spiteri Staines, Maurice Apap and John Licari, Journal of Electrical Systems and Information Technology, **4**, 347-358, (2017).
7. J. Singh, *Study and Design Grid Connected Solar Photovoltaic System at Patiala*, Punjab, July, 2010.
8. J. P. Benner, L. Kazmerski, IEEE Spectrum, **29** (9), 34-42, (1999).
9. Huan Liang Tsai, Ci Siang Tu, and Yi Jie Su, *Development of Generalize Photovoltaic Model Using MATLAB/SIMULINK on Engineering and Computer Science* (2008).
10. F. Lasnier and T. G. Ang, *Photovoltaic Engineering Handbook*, (1990).
11. Hsu-Chin Wu, Chia-Yi, Taiwan, Yaow-Ming Chen and Chia-Hsi Chang, *International Conference on Power Electronics and Drive Systems*, (2009).
12. [https://en.wikipedia.org/wiki/Solar\\_inverter](https://en.wikipedia.org/wiki/Solar_inverter)
13. Soeren Baekhoej Kjaer, John K. Pedersen, and Frede Blaabjerg, IEEE Transactions on Industry Applications, **41** (5), (2005).
14. A.E.W.H. Kahlane, L. Hassaine and M. Kherchi, Revue des Energies Renouvelables SIENR'14 Ghardaïa, 227 – 232, (2014)
15. R. Teodorescu, F. Blaabjerg, M. Liserre, U. Borup, *Proc. of APEC*, **1**, 580-586, (2004).
16. Mihai Ciobotaru, Remus Teodorescu and Frede Blaabjerg, *European Conference on Power Electronics and Applications*, (2005).
17. X. Yuan, W. Merk, H. Stemmler, J. Allmeling. Stationary Frame, IEEE Transaction in App., **38**(2), 523-532 (2002).
18. Zammit D, Spiteri Staines, Apap M, International Journal of Electrical and Computer Engineering **8** (2), (2014).