

Comparative assessment of the calculation of the sediment base of foundations by the SP method and the method of NRU "Geotechnika" MGSU and their analysis

Zaven Ter-Martirosyan^{1*}, Armen Ter-Martirosyan, and Nikita Kurilin

¹Moscow State University of Civil Engineering (MGSU), 129337, 26, Yaroslavskoye Shosse, Moscow, Russia

Abstract. The article provides a comparative assessment of methods for calculating the sediment of foundations of finite width with and without taking into account the horizontal movements of layers, as well as taking into account the self-weight of layers. As a calculation, to estimate the stress state of the base, the Flemann formulas are used (the plane problem), which allow us to determine the stress components σ_x , σ_z , τ_{xz} , as well as the average stress $\sigma_m = (\sigma_{xp} + \sigma_{zp})(1 + \nu)/3$, depending on the load intensity $p = \text{const}$ acting on the surface of the half-space along the strip $b = 2a$. In addition, this article provides formulas for determining the surface precipitation of a linearly deformable half-space $S(x, 0) = f(E, \nu, b = 2a)$.

1 Introduction

It is known that for the calculation of the precipitation of the bases of the final width at the present time, the normative document SP (set of rules) 22.13330.2016 (the main regulatory document of the Russian Federation in the field of geotechnics, further SP) recommends using the method of layer-by-layer compaction of soil layers in the compressible base layer in the absence of the possibility of lateral expansion and under the influence of the compacting load at an intensity equal to the maximum value $\sigma_{zp} = p_0(z)$ along the entire length of the layer.

It is assumed that this assumption under the condition of $\epsilon_x = \epsilon_y = 0$ compensates for the omission of the influence of horizontal displacements and stresses σ_{xp} and σ_{yp} on the sediment of the layer and therefore the sediment of the layer i according to the SP (set of rules) is determined by the formula

$$S_i = \frac{\sigma_{zpi}}{E_{0i}} \Delta z_i \beta(\nu_i) \quad (1)$$

* Corresponding author: asidorova@lan.spbgasu.ru

where $\sigma_{zp} = \sigma_{maxzp}(x)$ on condition $\varepsilon_x = \varepsilon_y = 0$; E_{0i} - modulus of total deformation; $\beta(v_i) = 0.8$ - coefficient, which is a constant independent of the real value of the Poisson's ratio of the soil v_i .

Based on (1), it is recommended to determine the base sediment by the formula:

$$S = \sum_{i=1}^{i=n} S_i \quad (2)$$

where n - the number of layers in the compressible thickness of the base.

Thus, the calculation of the foundation base precipitation is simplified as much as possible and is reduced to determining the minimum number of parameters $\sigma_{zp,i}$ and E_{0i} , while this method of calculating the layer precipitation with the restriction of horizontal movements in all types of dependence $\varepsilon - \sigma$, including Hencky, inevitably leads to a decrease in the sediment of layers. Note that the use of a compression curve to determine the modulus of deformation of the layers at each load stage is an approximate method. According to the results of three-axis tests, the determination of the strain modulus for compression conditions is problematic, since the strain modulus depends on the average stress σ_m .

The method of calculating the sedimentation of layers using the system of Hencky equations [1], which takes into account the nonlinear dependence, is devoid of these disadvantages $\varepsilon - \sigma$, including the dependence of the shear G and volume K strain modules on the stress state, moreover, with a linear dependence $\varepsilon - \sigma$ the system of Hencky equations passes to the system of Hooke equations. In addition, taking into account the possibility of horizontal displacements of layers makes it possible to use various nonlinear models of soils.

This article is devoted to a comparative assessment of the calculation of precipitation by SP and by REC as well as the justification of the method for calculating the sedimentation of foundations of finite width using the Hencky equation system, which takes into account all three stress components including the average stress σ_m . This method is based on the idea of representing the linear deformation of the soil layer $\varepsilon_z = \Delta S / \Delta z$ as the sum of the volume $\varepsilon_{z,\nu}$ and the shear $\varepsilon_{z,\gamma}$ components of the linear deformations ε_z in the form:

$$\varepsilon_z = \varepsilon_{z,\nu} + \varepsilon_{z,\gamma} \quad (3)$$

Indeed, the transformation of the system of linear Hooke equations leads to the dependence of $\varepsilon - \sigma$ to the form

$$\varepsilon_z = \frac{\sigma_{zp} - \sigma_m}{2G} + \frac{\sigma_m}{K} \quad (4)$$

where G and K are the modules of the shear and volume deformation of the layer, and

$$\begin{aligned} G &= E/2(1 + \nu), \\ K &= E/(1 - 2\nu), \\ \sigma_m &= (\sigma_{xp} + \sigma_{yp} + \sigma_{zp})/3 \end{aligned} \quad (5)$$

Note that the formula (4) was obtained by Z. G. Ter-Martirosyan [2] independently of the generalized Hencky equations [1]. It can be shown, that the usual Hooke equation is obtained from (4) if G , K , and σ_m from (5) are substituted into it. Formula (4) allows the use of G and K independently of each other, which are known to be determined based on standard triaxial tests (Figure 1). In addition, these tests allow you to determine the strength parameters of the soil.

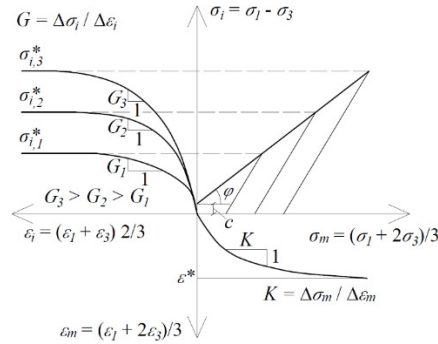

Fig. 1. Schematic representation of the results of standard three-axis tests of soils under the kinematic loading mode ($\dot{\epsilon}_1 = \text{const}$ and $\dot{\sigma}_1 = \text{const}$).

To determine the precipitation of a layer with a thickness of Δz_i on the basis (4), as in SP (set of rules), it is necessary to use the method of layer-by-layer summation of the sediment of the layers. Then we get:

$$\Delta S_i = \left(\frac{\bar{\sigma}_{zp,i} + \bar{\sigma}_{m,i}}{2G_i} + \frac{\bar{\sigma}_{m,i}}{K_i} \right) \cdot \Delta Z_i \tag{6}$$

where $\bar{\sigma}_{z,i}$ - weighted average value of the plot $\bar{\sigma}_{zp}$, i.e.

$$\bar{\sigma}_{z,i} = \frac{\int_{-\infty}^{+\infty} \sigma_{zp}(x) dx}{p \cdot b} \tag{7}$$

where p and b – the intensity and width of the load within $b = 2a$.

2 Comparative evaluation of the methods for calculating the precipitation of the elementary layer by sp and by nru mgsu, considered in this article

In contrast to the SP in the REC, the calculation scheme includes the average values $\bar{\sigma}_{zp}$ and $\bar{\sigma}_m(\bar{\sigma}_z)$ (Figure 2), and also $\bar{\sigma}_{xp}$, $G(\sigma_m)$ and $K(\sigma_m)$, moreover, b is the width of the loading band, p is the intensity of the load on the band. Below are the calculated schemes for determining the precipitation of the elementary layer with thickness Δz by SP and by NRU (Figures 2a, 2b). A schematic representation of the change in the shape of the load-bearing column (conditionally) under the foundation is also given when using the SP (set of rules), method and the NRU method (Figures 2b, 2g).

Comparative evaluation of JV and NRU methods:

- in the SP method, you must define σ_{zg} , σ_{zp} , $\sigma_x = \sigma_y = K_0 \cdot \sigma_{zp}$, E_0, ν_0 ;
- in the NRU method, you must define $\bar{\sigma}_{zg}$, $\bar{\sigma}_{zp}$, $\bar{\sigma}_{xp}$, $\bar{\sigma}_m$, $G(\sigma_m)$, $K(\sigma_m)$;
- in the SP method, one parameter is calculated - average layer sediment according to the formula $\Delta \bar{S}_i = \sigma_{zp} \cdot \Delta z_i \cdot \beta(\nu_i)/E_{0i}$, on condition $\beta(\nu_i) = 0.8$;
- several parameters are calculated in the NRU method $\Delta \bar{S}_z$, $\Delta \bar{S}_x$ (if necessary), moreover $\Delta \bar{S}_z = \Delta \bar{S}_{z,y} + \Delta \bar{S}_{z,v}$, $\Delta \bar{S}_{z,y} = \frac{\bar{\sigma}_z - \bar{\sigma}_m}{2G}$, $\Delta \bar{S}_{z,v} = \frac{\bar{\sigma}_m}{K}$;
- in the SP (set of rules) method, the calculation of the layer precipitation always ends with stabilization, both in the linear and nonlinear formulation due to the condition $\epsilon_x = \epsilon_y = 0$;

- in the NRU method, the calculation of the sediment of layers can be stabilized in the linear setting, and in the elastic-plastic setting it can not be stabilized and continue to develop up to the undamped values of the sediment. The obvious difficulties in the NRU method are justified by the fact that it allows you to calculate the base subsidence at $p > R$ (where R is the calculated resistance of the base soil) within the specified limits p . Such a forecast is necessary when designing the foundations of buildings and structures, because it allows you to use the reserves of load-bearing capacity and take the optimized dimensions of the foundation at a given precipitation. Figure 3 shows a schematic representation of the dependencies $\Delta S - \Delta \sigma_z$ by the SP method and by the NRU method. The next section of this paper provides a computational and theoretical justification of the curves $\Delta S - \Delta \bar{\sigma}_{zp}$ including $\Delta S\gamma$ and ΔSv .

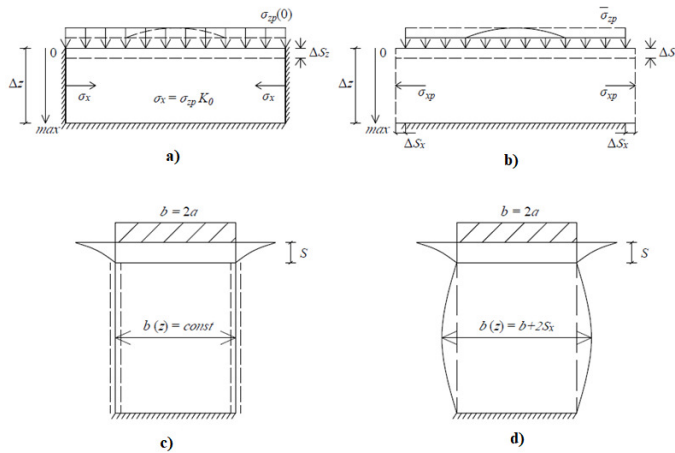

Fig. 2. Calculation schemes for determining the precipitation of a layer with a thickness of Δz according to the SP method (a) and the NRU MGSU, method (b) and the shape of the supporting pillar under the foundation according to the SP method (b) according to the NRU method (g).

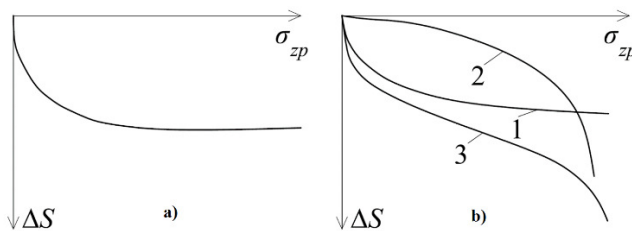

Fig. 3. Schematic representation of the development of the layer sediment by the SP (a) method and by the NRU method (b), including ΔSv (1), $\Delta S\gamma$ (2) and $\Delta S = \Delta Sv + \Delta S\gamma$ (3).

3 Theoretical foundations of the forecast of the sedimentation of the foundations of the foundations by the rec method (flat problem)

3.1 Components of the stress state in the base

It is known that the components of the stress state in the ground half-space under the action of the load on the band $b = 2a$ are determined by the Flemann formulas in the form:

$$\sigma_x = \frac{p}{\pi} \left[\operatorname{arctg} \frac{a-x}{z} + \operatorname{arctg} \frac{a+x}{z} \right] + \frac{2apz(x^2 - z^2 - a^2)}{\pi \cdot [(x^2 + z^2 - a^2)^2 + 4a^2z^2]}$$

$$\sigma_z = \frac{p}{\pi} \left[\operatorname{arctg} \frac{a-x}{z} + \operatorname{arctg} \frac{a+x}{z} \right] - \frac{2apz(x^2 - z^2 - a^2)}{\pi \cdot [(x^2 + z^2 - a^2)^2 + 4a^2z^2]} \quad (8)$$

$$\sigma_m = \frac{2p \cdot (1+\nu)}{3\pi} \left[\operatorname{arctg} \frac{a-x}{z} + \operatorname{arctg} \frac{a+x}{z} \right] \quad (9)$$

$$\sigma_z - \sigma_m = \frac{2p}{\pi} \left(\frac{a \cdot z}{a^2 + z^2} + \frac{1-2\nu}{3} \operatorname{arctg} \frac{z}{a} \right) \quad (10)$$

On the basis of these formulas in the work of V. A. Florin (1959), a table is compiled for σ_x/p and for σ_z/p .

However, determining the weighted average value $\bar{\sigma}_{zp}$, acting on the layer results in false expressions:

$$\bar{\sigma}_{zp} = \int_{-l}^{+l} \frac{\sigma_{zp}(x) dx}{p \cdot b} \quad (11)$$

where b and p are the width of the foundation and the intensity of the load under the foundation;

At the same time, the view of the curve $\sigma_{zp}(x)$ (Figure 4) given in the work of V. A. Florin (Figure 4) is similar to the Gaussian probability curve. This allows the curve $\sigma_{zp}(x)$ to be represented as:

$$\sigma_{zp}(x) = p_0(z) e^{-\alpha x^2} \quad (12)$$

where $p_0(z)$ - the maximum intensity of the load on the layer at $x = 0$ and at depth z , and at $z = 0$, $p_0(z) = p$.

α - a curve parameter that can be determined from the equilibrium condition (11) in the form

$$p \cdot b = p_0(z) \int_{-l}^{+l} e^{-\alpha x^2} dx, (l \gg b) \quad (13)$$

This integral is known and the formula (13) takes the form:

$$p \cdot b = p_0(z) \left(\frac{\pi}{\alpha} \right)^{1/2} \quad (14)$$

It follows that

$$\alpha = \pi \left(\frac{p_0(z)}{p \cdot b} \right)^{1/2} \quad (15)$$

Thus we get

$$\bar{\sigma}_{zp} = \frac{p_0(z)}{p \cdot b} \left(\frac{\pi}{\alpha} \right)^{1/2} \quad (16)$$

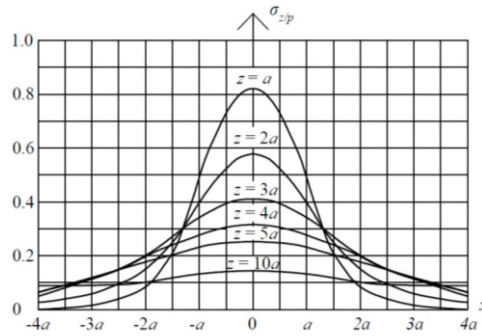

Fig. 4. Epures σ_z/p according to Flaman (Florin, 1959).

3.2 Relationship between stress and strain by Hencky

Hencky's system of equations [1] summarizes the proposal of Z. G. Ter-Martirosyan (1984 r.) [2] 2020) formula (4) regardless of Hencky [1]. We give a general view of the system of linear and nonlinear dependence $\sigma - \varepsilon$ by Hencky, they have the form:

$$\begin{aligned} \varepsilon_x &= \chi(\sigma_x - \sigma_m) + \chi^* \cdot \sigma_m; & \gamma_{xy} &= 2\chi \cdot \tau_{xy} \\ \varepsilon_y &= \chi(\sigma_y - \sigma_m) + \chi^* \cdot \sigma_m; & \gamma_{yz} &= 2\chi \cdot \tau_{yz} \\ \varepsilon_z &= \chi(\sigma_z - \sigma_m) + \chi^* \cdot \sigma_m; & \gamma_{zx} &= 2\chi \cdot \tau_{zx} \end{aligned} \quad (17)$$

Where

$$\chi = \frac{\gamma_i}{2\tau_i} = \frac{f(\tau_i, \sigma_m, \mu\sigma)}{2\tau_i}; \quad \chi^* = \frac{\varepsilon_m}{\sigma_m} = \frac{f^*(\tau_i, \sigma_m, \mu\sigma)}{2\tau_i} \quad (18)$$

τ_i – the intensity of tangential stresses, $\mu\sigma$ - parameter of the SSS (stress-strain states) Lode-Nadai coefficient [3].

3.3 Calculated models of soil bases

In the case of linear deformation from (17) we obtain:

$$\chi = \frac{\gamma_i}{2\tau_i} = \frac{1}{2G}; \quad \chi^* = \frac{\varepsilon_m}{\sigma_m} = \frac{1}{K} \quad (19)$$

moreover, the system of Hencky's equations passes into the system of Hooke's equations [2].

As a computational model for determining nonlinear volume deformations, we take the dependence of the form proposed by S. S. Grigoryan [4]:

$$\varepsilon_m(\sigma_m) = \varepsilon^*(1 - e^{-a\sigma_m}) \quad (20)$$

where ε^* - limit value of the average strain (Figure 5a) $\varepsilon_m = \varepsilon_z / 3$ by $\sigma_m \rightarrow \infty$,
 a - non-linearity parameter, $\sigma_m = (\sigma_x + \sigma_y + \sigma_z)/3$.

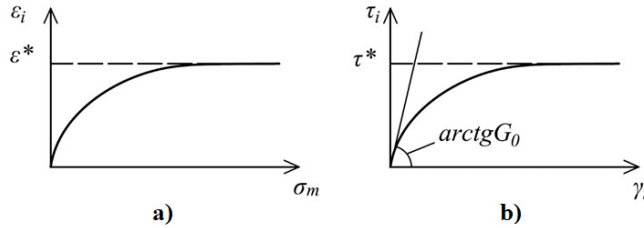

Fig. 5. General view of dependencies $\varepsilon_i - \sigma_m$ (a) and $\tau_i - \gamma_i$ (b)

In this case, the secant modulus of the volume strain K can be determined by dividing in the expression (16) ε^* , by σ_m i.e.

$$\frac{1}{K} = \frac{\varepsilon^*}{\sigma_m} (1 - e^{-\alpha\sigma_m}) \quad (21)$$

And for $\sigma_m \rightarrow \infty$; $K \rightarrow \infty$, and for $\alpha = 0$; $\varepsilon_m^* = \varepsilon_m$ we get the linear dependence $\varepsilon_m = \sigma_m / \varepsilon_m$.

The tangent modulus of deformation can be determined by differentiating the expression (20) by σ_m , i.e. we obtain

$$K_k = \frac{e^{\alpha\sigma_m}}{\varepsilon^*\alpha}; \frac{1}{K_t} = \varepsilon^* \alpha e^{-\alpha\sigma_m} \quad (22)$$

When unloading, we get $\varepsilon_m = \frac{\sigma_m}{K_0}$ and $K_0 \rightarrow K$.

We also assume that in the process of loading, the elastic-plastic properties of clay soil during shear are described by the formula of S. P. Timoshenko [5], which, as applied to soils, has the form:

$$\gamma_i = \frac{\tau_i}{G^e} \frac{\tau_i^*}{\tau_i^* - \tau_i} \quad (23)$$

where τ_i , τ_i^* - the effective and limit values of the intensity of tangential stresses (Figure 5b), and:

$$\tau_i^* = (\sigma_m + \sigma_g) \cdot tg\varphi_i + c_i \quad (24)$$

where φ_i , c_i are the limit values of strength parameters determined by the limit line in the plane $\tau_i - \sigma_m$ (Figure 1); G^e - is the shear modulus at $\tau_i \rightarrow 0$, and $\gamma_i^e = \frac{\tau_i}{G^e}$. In the presence of over-compacted soils, it is necessary to use the residual stress in the over-compacted soils, determined by the results of compression tests by the Casagrande method [6].

4 Calculation of the sediment of a linearly deformable base using the NRU method

In the simplest case of a linear relationship between stresses and deformations with the parameters G and K , the draft can be determined by an analytical solution for the z axis ($x = 0$). Then we can write

$$S = \int_0^{h_a} \frac{\sigma_m}{K} dz + \int_0^{h_a} \frac{\sigma_z - \sigma_m}{2G} dz \quad (25)$$

where h_a - compressible thickness capacity; σ_z and σ_m are determined by (9) and (10), respectively.

Stresses σ_m and $\sigma_z - \sigma_m$ on z ($x = 0$) axis change with depth according to (10) and (11) as follows

$$\sigma_m = \frac{4p(1+\nu)}{3\pi} \operatorname{arctg} \frac{a}{z} = \frac{4p(1+\nu)}{3\pi} \operatorname{arctg} \frac{z}{a} \quad (26)$$

Substituting (26) in the first integral (25), we obtain the base sediment within h_a from the volume strain

$$S_v = \frac{4p(1+\nu)}{3\pi K} \left[h_a \operatorname{arctg} \frac{h_a}{a} + \frac{a}{2} \ln \frac{a^2 + h_a^2}{a^2} \right] \quad (27)$$

After substituting (11) in the second integral (25), we obtain the base sediment from shear deformations within h_a

$$S_\gamma = \frac{p}{3\pi \cdot G} \left[(1 - 2\nu) h_\gamma \operatorname{arctg} \frac{h_a}{a} + (2 - \nu) a \ln \frac{a^2 + h_a^2}{a^2} \right] \quad (28)$$

It can be seen from (27) and (28) that S_γ and S_v depend non-linearly on the geometric parameters of the problem; i.e., on; a , h_a and h_γ . It is also important to note that with $h_a = h_\gamma$ and $S_\gamma > S_v$.

Let's consider an example with the source data $a = 2$ m, $h_a = 6$ m, $\nu = 0.33$, $K = 40000$ kPa, $p = 400$ kPa, $G = 5113$ kPa. Solution (27) and (28) showed that $S_v = 2.18$ cm, $S_\gamma = 21.05$ cm. It is important to note that $S_\gamma > S_v$.

5 Taking into account the nonlinear deformation of the soil when calculating the precipitation of the base soil layer under conditions of compression compression ($\varepsilon_x = \varepsilon_y = 0$)

In the nonlinear formulation, σ_x should be determined based on the geometric conditions of compression compression [2], i.e. we have:

$$\varepsilon_m = \frac{\varepsilon_z}{3}; \gamma_i = \varepsilon_z \cdot \frac{2}{\sqrt{3}}; \tau_i = \frac{(\sigma_z - \sigma_x)}{\sqrt{3}} \quad (29)$$

In addition, it follows from the generalized Hencky equation (17) that:

$$\varepsilon_z = \frac{\sigma_z - \sigma_m}{2\bar{G}} + \frac{\sigma_m}{\bar{K}}; \varepsilon_x = \varepsilon_y = \frac{\sigma_x - \sigma_m}{2\bar{G}} + \frac{\sigma_m}{\bar{K}} = 0 \quad (30)$$

where $\bar{G} = G^e \frac{\tau_i^* - \tau}{\tau_i^*}$; $\bar{K} = \frac{\sigma_m}{\varepsilon^*(1 - e^{-\alpha\sigma_m})}$; $\tau_i \rightarrow \tau_i^*$; $\bar{G} \rightarrow G^e$; $\sigma_m \rightarrow 0$; $\bar{K} = K_t(0) = \frac{1}{\alpha\varepsilon^*}$; $\sigma_m \rightarrow \infty$; $\bar{K} \rightarrow \frac{\sigma_m}{\varepsilon^*}$.

Under compression conditions $\varepsilon_x = \varepsilon_y = 0$, then from (30) we get

$$\frac{\sigma_x - \sigma_m}{2\bar{G}} + \frac{\sigma_m}{\bar{K}} = 0 \quad (31)$$

Substituting \bar{G} and \bar{K} in this equation, we get

$$\frac{(\sigma_x - \sigma_m)\tau_i^*}{2G e^{(\tau_i^* - \tau)}} + \varepsilon^*(1 - e^{-\alpha\sigma_m}) = 0 \tag{32}$$

This is a transcendental equation with respect to the unknown lateral pressure $\sigma_x = \sigma_z$ as a function of σ_z . Defining them using the PC MathCad and substituting in (25), we get the compression curve $\varepsilon(\sigma)$. Figure 6 shows the results of calculating the dependencies $\varepsilon_z(\sigma_z)$, $\varepsilon_{z,v}(\sigma_z)$, $\varepsilon_{z,\gamma}(\sigma_z)$, as well as $\sigma_x(\sigma_z)$ for loading and unloading on the basis of (25) using a PC MathCad. From the analysis of the curves, it can be seen that $\varepsilon_z(\sigma_z) = \varepsilon_{z,v}(\sigma_z) + \varepsilon_{z,\gamma}(\sigma_z)$. In addition, their residual values are recorded during elastic unloading. The residual σ_x is also fixed on the $\sigma_x - \sigma_z$ curve.

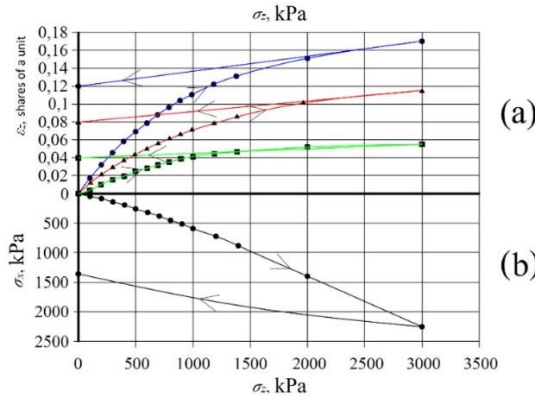

Fig. 6. The dependences of the total $\varepsilon_z(\sigma_z)$ (blue line), the volume components $\varepsilon_{z,v}(\sigma_z)$ (red line) and the shear components $\varepsilon_{z,\gamma}(\sigma_z)$ (green line) of the total strain (a), as well as the lateral pressure σ_x (b) on the vertical σ_z , calculated by formulas (23) - (25)

As expected, the curve $\varepsilon - \sigma$ has a damping character with increasing σ , which is due to the conditions of compression ($\varepsilon_x = \varepsilon_y = 0$).

We show that for free horizontal movement of the layer ($\varepsilon_x \neq 0, \varepsilon_y \neq 0$), when σ_{zp}, σ_{xp} and $\sigma_m = (\sigma_{zp} + \sigma_{xp})(1 + \nu) / 3$ act, soil deformations ε_z can have a damped and non-damped character, depending on the value of σ_{zp} and the ratio of the intensities of tangential stresses τ^*i and τ_i (19).

6 Taking into account the nonlinear deformability of the soil layer in the calculation of its precipitation under the condition of its free movement in the horizontal direction ($\varepsilon_x \neq 0$) under the influence of σ_{zp}, σ_{xp} and σ_m

In this case, the solution of the problem is reduced to the consideration of equation (4), which in this case is written as

$$\varepsilon_z = \frac{\sigma_z - \sigma_m}{2G(\sigma_m, \tau_i)} + \frac{\sigma_m}{K(\sigma_m)} \tag{33}$$

where $G(\sigma_m, \tau_i)$ and $K(\sigma_m)$ are determined by the formula:

$$G(\sigma_m, \tau_i) = G e^{\frac{\tau_i^* - \tau_i}{\tau_i}}; K(\sigma_m) = \frac{\sigma_m}{\varepsilon^*(1 - e^{-\alpha\sigma_m})} \tag{34}$$

where $\tau_i^* = \sigma_m \cdot tg\varphi + c$; and, for $\tau_i \rightarrow \tau_i^*$,
 $G(\sigma_m, \tau_i) \rightarrow 0$, and, for $\alpha = 0$ and $\varepsilon^* = \varepsilon$, $K \rightarrow \frac{\sigma_m}{\varepsilon_m}$.

Substituting the values of $G(\sigma_m, \tau_i)$ and $K(\sigma_m)$ from (37) to (36) we obtain a nonlinear equation with respect to $\varepsilon_z - \sigma_z$ at the constant $\sigma_x = \text{const}$, both for $\varepsilon_{z,v}$ and for $\varepsilon_{z,\gamma}$, i.e.

$$\varepsilon_{z,v} = \varepsilon^* \left(1 - e^{-\alpha \frac{(\sigma_z + \sigma_x)(1+\nu)}{3}} \right) \tag{35}$$

$$\varepsilon_{z,\gamma} = \frac{\sigma_z - (\sigma_z + \sigma_x)(1+\nu)/3}{2G^e(1-\tau_i/\tau_i^*)} \tag{36}$$

where $\tau_i^* = \left(\frac{(\sigma_z + \sigma_x)(1+\nu)}{3} + \sigma_g \right) \cdot tg\varphi + c$; $\tau_i = \frac{(\sigma_z - \sigma_x)}{\sqrt{3}}$; σ_{xp} and σ_{zp} are defined by (8), σ_g is natural tension.

Similarly, we can write equations (35) and (36) to determine the components $\varepsilon_{x,v}$ and $\varepsilon_{x,\gamma}$. The axial deformations ε_z at different verticals $x \geq 0$ are shown in Figure 9.

From the analysis of equations (35) and (36) it follows that the component of the volume strain $\varepsilon_{x,v}$ with the growth of σ_z will have a damped character and at $\sigma_z \rightarrow \infty$; $\varepsilon_{z,v} \rightarrow \varepsilon^*$. At the same time, with the growth of σ_z the value $\varepsilon_{z,\gamma}$ will have a non-damping character, since at $\tau_i \rightarrow \tau_i^*$; $\varepsilon_{z,\gamma} \rightarrow \infty$. Therefore the total amount of deformation will have a double curvature, i.e., at the initial site $\tau_i < \tau_i^*$ $\varepsilon_{z,v}$ has a damping character, and then at $\tau_i \rightarrow \tau_i^*$ it goes to the stage of progressive deformation (Figure 7).

Solving the example based on (35) and (36) using a PC MathCad when $\varepsilon^* = 0.016$; $\alpha = 0.005$;

$G_e = 50000$ kPa; $\nu = 0.3$; $\varphi = 25^\circ$; $c = 10$ kPa (the depth of the deformation record is 8 meters) confirmed our analysis of formulas (35) and (36) and their sum.

The S - p graph on the $x = 0$ axis, constructed by summation for different parameters of deformability ($G_e, \nu, \varepsilon^*, \alpha$) and strength (φ and c) is shown in Figure 9 [7].

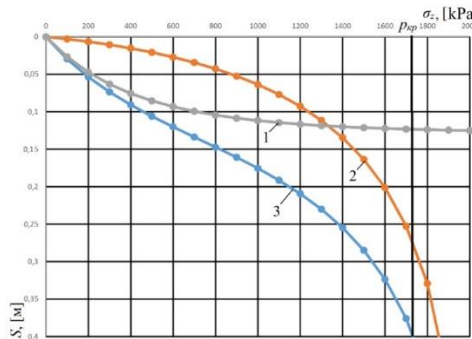

Fig. 7. Graphs of the curves of the precipitation of the soil layer with a thickness of $h = 8$ m with free horizontal movement ($\varepsilon_x \neq 0, \sigma_x = \text{const}$), calculated by the formulas (35) and (36): 1 - $\varepsilon_{z,v}$; 2 - $\varepsilon_{z,\gamma}$; 3 - $\varepsilon_z = \varepsilon_{z,v} + \varepsilon_{z,\gamma}$

A comparison of the curves $\varepsilon_z - \sigma_z$ in Figure 8 shows their significant difference. Obviously, the same difference can occur in the draft-load (S - p) curves when calculating the foundation draft, since $S = \sum_{i=1}^{i=n} \varepsilon_{z_i} \cdot \Delta z_i$. Then the sediment-load relationship will have the form (Figure 8).

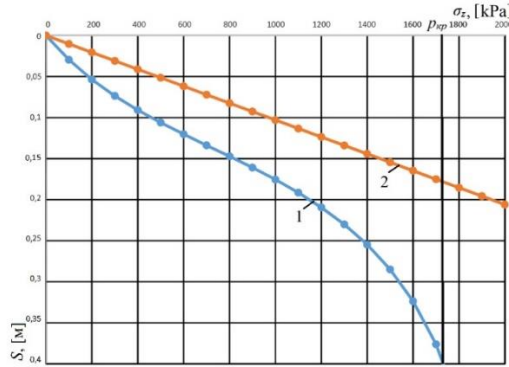

Fig. 8. The dependence of the sediment is the load ($S - p$) of a non-linearly deformable foundation base of finite width, taking into account (1) (the NRU model) and not taking into account (2) (the SP model) horizontal displacements of layers in the compressible thickness of the base, calculated by formulas (35) and (36), as well as by the method of layer-by-layer summation.

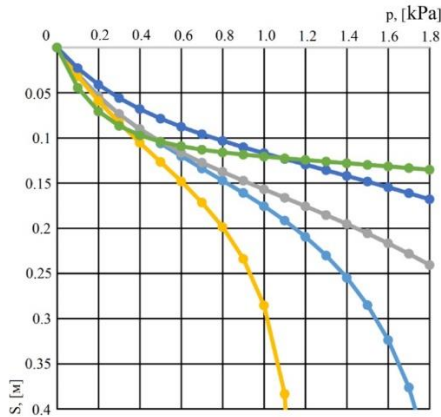

Fig. 9. The $S - p$ graph on the $x = 0$ axis is constructed by summation for different parameters of deformability (G_e , v , ε^* , α) and strength (ϕ and c).

7 Conclusions

In this paper, a comparative assessment and analysis of the methods for calculating the sediment of the SP and NRU "Geotechnika" MGSU is given, during which the following points are noted:

1. The SP method is based on the condition of compressive compression of the layers ($\varepsilon_x = \varepsilon_y = 0$ which, for any law of deformation of the layers in the compressible thickness, leads to the stabilization of the sediment, i.e., with an increase in σ_z the parameter $\varepsilon_z \rightarrow 0$).
2. The method of NRU "Geotechnika" MGSU is based on the condition of free horizontal displacements of layers from the compressible thickness of the foundation soil and, depending on the parameters of the volumetric and shear deformations of the Hencky, it can have both a damped and non-damped character of double curvature, including the total sediment of the base of foundations of the same width. The method of NRU "Geotechnika" MGSU allows you to predict the base sediment beyond $R > p$ calc, but the SP method does not.

3. Along with the SP (set of rules) method, the method of NRU "Geotechnika" MGSU should be added to the regulatory document as an additional method necessary for predicting the sediment of the foundations of buildings and structures of increased responsibility

References

1. H. Hencky, 1924. Zur Theorie plastischer Deformationen und der hierdurch im Material hervorgerufenen Nachspannungen (ZaMM, 323-334, 1924)
2. Z.G. Ter-Martirosyan, A.Z. Ter-Martirosyan, Mechanics of Soils (ASV, Moscow, 2020)
3. Yu.L. Rebetsky, N.A. Sycheva, V.N. Sychev, S.I. Kuzikov, A.V. Marinin, Russ. Geol. Geophys. **57(3)**, 387–408 (2016). doi: <https://doi.org/10.1016/j.rgg.2016.03.003>.
4. Z.G. Ter-Martirosyan, A.Z. Ter-Martirosyan, Soil Mech Found Eng 55, 291–297 (2018). <https://doi.org/10.1007/s11204-018-9539-8>.
5. S.P. Timoshenko, J. Gudier, Theory of Elasticity (Nauka, Moscow, 1975)
6. A. Casagrande, The determination of the pre consolidation load and its practical significance Proc. ICOSMFE, Cambridge **3**, 60-64 (1936).
7. Z.G. Ter-Martirosyan, A.Z. Ter-Martirosyan, N.O. Kurilin, Soil Mech. Found. Eng. **58**, 18–24 (2021). <https://doi.org/10.1007/s11204-021-09702-6>.