

A Study of Real-Time System of Water Distribution Networks: Case study of Hat Yai Waterwork Plant, Songkhla Province, Thailand

Sittichai Jandaeng¹ and Chalida U-tapao^{1,*}

¹Department of Civil Engineering, School of Engineering, King Mongkut's Institute of Technology Ladkrabang, Bangkok 10520, Thailand

Abstract. This study aims to optimize water distribution in a water supply network. One of the most important objectives for every waterwork plants is to minimize water loss in supplying system. The water supply network in Thailand is underground work and most of them have used for many years. Leakages are normally met especially when high pressure are required from demand side. This research will classify 13,580 households living around Hat Yai waterwork plant of Provincial Waterworks Authority in Hat Yai branch in Songkhla province as a demand side and put 5 water sources of Hat Yai district as a supplied side. EPANET program is used to simulate water distribution networks and SCADA application is selected to design controlling system. The result shows that water supply at the Hat Yai waterwork plant should be at least 48 meters to upper Hat Yai zone, however, booster pump may help reducing original water head to 40 meters into high-level areas. Hat Yai waterwork plant decreases energy consumption from pumping processes and also reduce water loss in water distribution system.

1 INTRODUCTION

Thailand population is 70 million people. About 10 million who live in Bangkok (capital city) get water supply from Metropolitan Waterworks Authority, but 67 million people who live in other provinces use water from many sources such as Provincial Waterworks Authority, village water supply or ground water. Water quality and quantity are both necessary issues to think about as well as the reduction of water supply's operational costs. This research focus on how to be quantified water to people who live in urban area such as Hat Yai district, Songkhla province (Southern part of Thailand) and minimize energy consumption from pumping process. 852.80 square kilometres of Hat Yai is shown in Figure 1 and there are 404,365 population [5].

Water distribution process normally pump treated water up to high tank tower and let water flow down to particularly houses. However, this pumping process consumes high energy to storage large amount of water upon high tank tower [1]. This transmission process has to be prepared and ready to use either consumers need or don't need water supply. Distribution process will be installed and separates water supply to each household via piping system. This process might cause energy lost in this transmission and distribution systems.

Piping system in Thailand, especially water distribution is underground work having used for many years. We might not fully trust them 100% quality. Leakage can appear in everywhere, so water may lost depend upon pressure in pipeline. The more we can reduce pressure, the more we can deduct water lost in water distribution network [2].

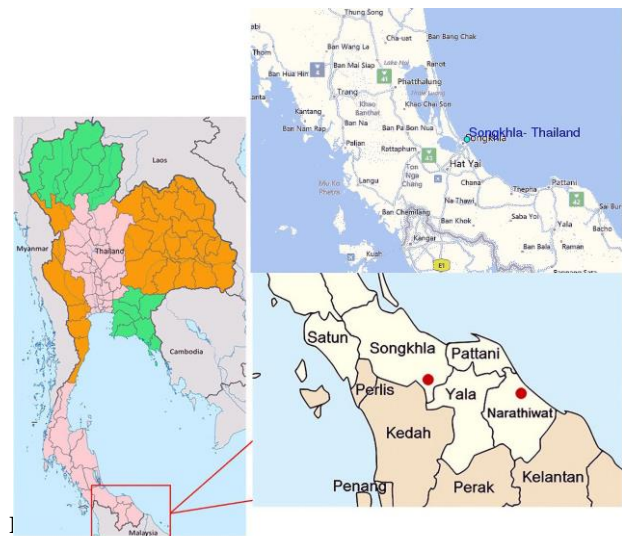

Fig. 1.

Our team design another way to reduce energy consumption and water lost in water distribution network. We will not use high tank tower but compare demand with supply sides. Realtime model of 13,580 households (demand side) and 5 water sources (supply side) are simulated via EPANET program. Needing pressure will put on SCADA application to control water pump at the original station. Furthermore, some high-level areas may need more pressure from booster pumps [4].

The result of this study will improve water supply distribution networks, especially for urban areas to reduce energy consumption and water leakage along with water flow in pipe.

* Corresponding author: chalida.ut@kmitl.ac.th

2 Methodology

This research surveyed 13,580 households, who lives in Hat Yai district, Songkhla province, to get elevation, population, and water consumptions within 440 days. Data is approximated to demand of water consumption per hour. Base demand is calculated by approximated water consumption 100 liters per person per day and four persons for each household. Figure 2 in used to descript this research methodology [9-11]. Collected data has been put on EPANET program to build up water demand model [6]. Figure 3 shows elevations for each sample point. All areas have difference elevations, and we will consider them as upper streams and lower streams areas.

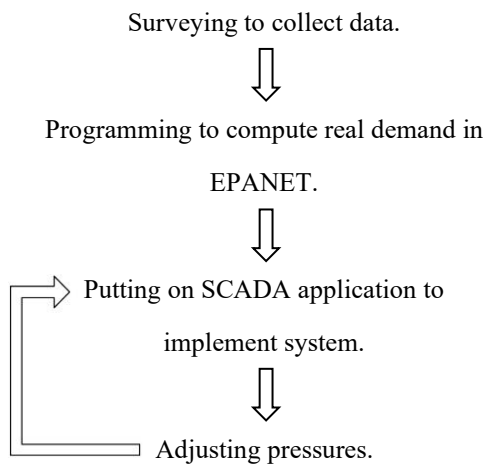

Fig. 2. shows this research methodology.

EPANET is used to simulate each period of water pressure related with water flow for specific location. Figure 4 shows simulated water pressure for each sample point. According to collecting data, waterwork plant must use 48 meters (water pressure) at the upstream and downstream will put different data related with real elevations. Furthermore, EPANET is used to simulate all water pressures at different elevations. A main pump, installing at the start point, must provide at least 48 meters to get enough water pressure at all areas. In November 2022, waterwork consumed 110,112.00 kWh and lose 42,769 m³. Our assumption is Hat Yai waterwork plant should reduce both electricity consumption and water lost by using booster pumps in specific areas.

SCADA (Supervisory Control and Data Acquisition) application as license program is used to control and adjust water pressure in water distribution system. Water will be supplied to Hat Yai's population within their demands. Figure 5 shows SCADA application that uses to control pumping system and water pressure for the upstream station.

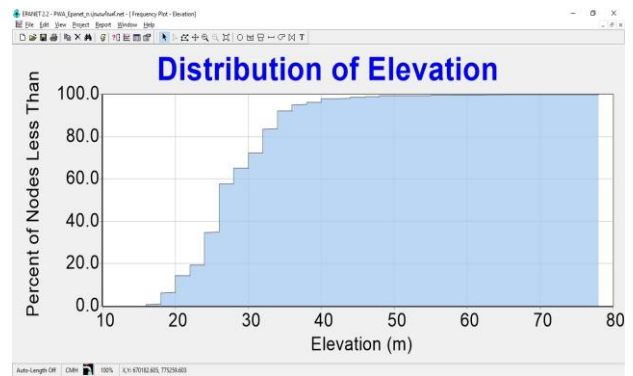

Fig. 3. Elevation of 13,580 households living in Hat Yai District, Songkhla province.

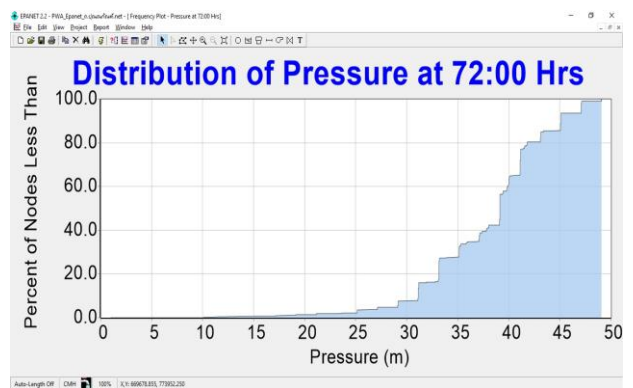

Fig. 4. Water pressure for each sample spot.

Figure 5 shows a relation between water pressure $f(x)$ in meters and flow rate x in cubic meter per hour is in polynomial equation [9-11].

$$f(x) = a_n x^n + a_{n-1} x^{n-1} + \dots + a_2 x^2 + a_1 x^1 + a_0 \quad (1)$$

Equation 1 represents a function of water pressure of base demand (cubic meter per hour) for each household.

We put default value through the SCADA application by using base demand the pressure for each period by using base demand (calculated by equation 1). As a result, we must input some pressure value in accordance with the output equation, and the pressure value determined by this equation is referred to as the desired value or set value.

The total flow rate input and pressure transmitter sensor are used to measure the pressure in the water supply network. By means of the master flow meter directly linked to the function equation, we refer to this as feedback or actual value.

Any discrepancy between these two signals, the feedback or real value and the setpoint value, denotes our error. Based on this comparison in the form of real time function, the equation controller will produce results and send the output to the vary speed pump via the SCADA Application.

Here, we use the variable speed pump to regulate the water supply flow to maintain the water supply network's pressure. The controller output function equation used here determines the position of this variable speed pump. To meet the Base Demand in each pattern period of tap water demand, the process' response time is dependent on three values: proportional gain, integral time, and derivative time.

To control exceeding energy consumption of pumping and protecting piping system, we must adjust inputting elevation data. For example, minimum elevation is h_n , maximum elevation is h_m and the difference elevation data is less than or equal to vary speed pump (h_g).

$$h_g \leq h_m - h_n \quad (2)$$

$$h_m \geq 0 \quad (3)$$

$$h_n \geq 0 \quad (4)$$

All elevations will input as constraints via SCADA application as shown in Fig. 6.

Both upstream and downstream pumps are adjusted water pressures shown in fig. 7 and the elevations are also controlled. Minimum energy consumption of water pump is optimized and shows in equation (5)

$$\min(OBJF) = \min \left(\sum_{i=1}^n |EU_i + ED_i| \right) \quad (5)$$

$i = 1 \dots n$ are time, EU is energy consumption of upstream pump, and ED is energy consumption of downstream pump.

Time is another variable affect energy consumption and flow rate. We need to supply all consumer demands, however, different period of time will have different demand. On-Peak times are 05:00 – 10:00 am and 4:00 – 10:00 pm are high demand but we must control exceeding energy consumption. Off-Peak times 11:00 am – 04:00 pm and 10:00 pm – 05:00 am are lower demand and we can reduce energy consumption. Optimization model is used to minimizing energy consumption subjected to elevations constraints. Various pumps are controlled real time via SCADA application shown in fig. 8 and 9.

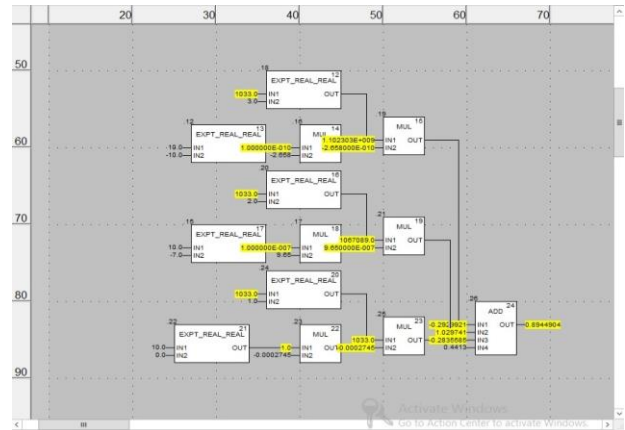

Fig. 5. The relationship between water pressure and flow rate

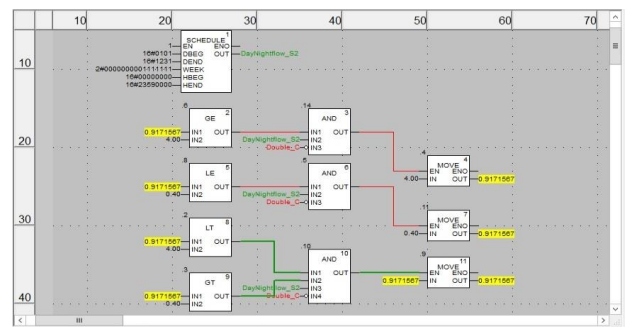

Fig. 6. Vary speed pump to control pump

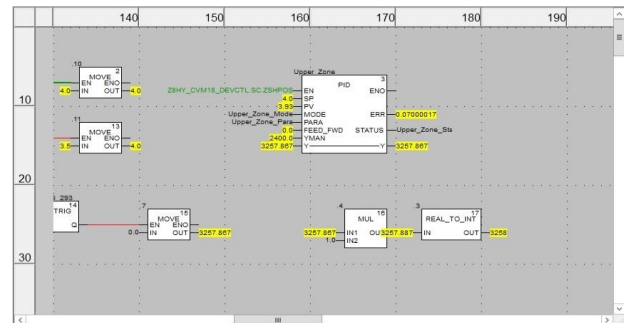

Fig. 7. Result from SCADA Application used to control water pressure.

Many areas we could use booster pumps to improve water pressure in specific times (peak load) and specific locations. We don't need to supply high pressure at the upstream for all water networks.

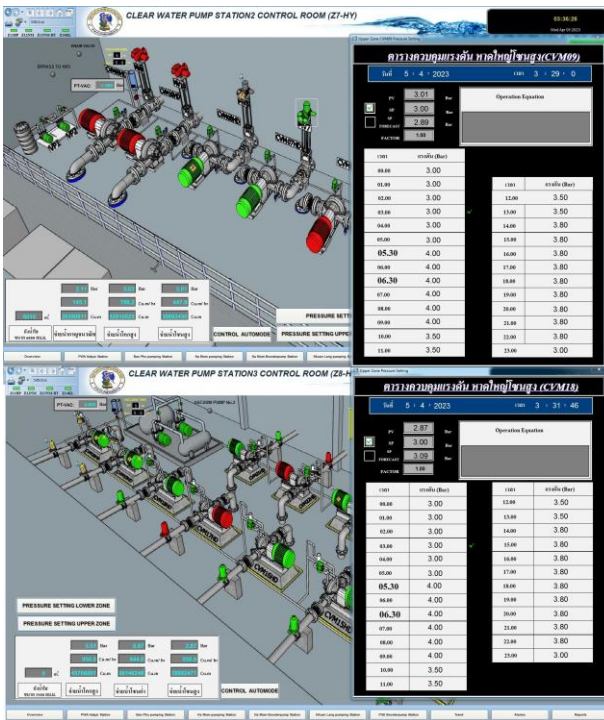

Fig. 8. The SCADA application is setting water pressure for the upstream station at various times.

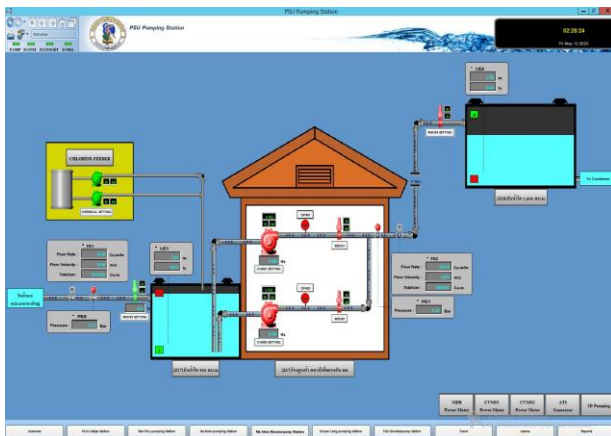

Fig. 9. SCADA application controls water pressures at pumping system

3 Results and Discussion

Collected data has shown significant information about different demand of Hat Yai population related on different period. It is no need to put on high energy to storage large amount of water on high tower. Booster pumps are installed between the upstream and downstream to push the water and thoroughly serve water to the downstream users [8]. Fig 6-8 show demand site, example, area of 14 kilometre's diameter. If we install boosters pump at between 7 kilometres, we will not need to transmit huge amount of water on higher level. Booster pump will operate at real time and reduce exceed energy consumption. The average supplying pressure of the upstream is 48 meters simulated from

EPANET program. However, many points at the downstream location can reduce demanding pressure to 40 meters [7]. SCADA application will control pumping system following solution of EPANET and reduce 22% of energy consumption.

Clearly, 18% of water loss will also reduce when water pressure is reduced in piping system. Many locations reduce water pressure between upstream and downstream from 48 to 40 meters in this case.

4 Conclusion

Investigated the problem of optimal control of water distribution networks without storage capacity. The author chose programming to compute real demand in EPANET and putting on SCADA application to adjusting pressure. The author proposed energy consumption and water loss will also reduce when the upstream water pressure is reduced in water distribution network.

References

1. I. Sarbu, *A Study of Energy Optimisation of Urban Water Distribution Systems Using Potential Elements*. Journal of Water 2016, **8**, 593 (2016)
2. R. Wannapop, T. Jearsiripongkul and K. Jiamjiroch, *Effect of Nodal Elevation Revision in Water Distribution System: A Case Study of Metropolitan Waterworks Authority, Thailand*. International Journal of GEOMATE, Jan. 2019, **16**, Issue 53, pp.184-189. (2019)
3. S. Ngeranna, N. Rachaphaew, P. Prikchoo, O. Kaewnah, K. Manopwisedjaroen, K. Phumchuea, C. Suansomjit, W. Roob-soong, J. Sattabongkot, S. Thammapalo, L. Cui, and W. Nguitragool, *Case Report: Case Series of Human Plasmodium knowlesi Infection on the Southern Border of Thailand*, The American journal of tropical medicine and hygiene, pp.1397-1401. (2019)
4. N. Trifunović, *Introduction to Urban Water Distribution Handbook*, Second Edition. (2020)
5. Department Of Provincial Administration Homepage, <https://www.dopa.go.th>, last accessed 2023/05/12
6. U.S. Environmental Protection Agency, <https://www.epa.gov/water-research/epanet>, last accessed 2023/05/12
7. M. P. Conejos, F. M. Alzamora, J. C. Alonso, *A Water Distribution System Model to Simulate Critical Scenarios by Considering Both Leakage and Pressure Dependent Demands*. XVII International Conference on WDSA2016, pp.380-387. (2017)
8. J. Marques, M. Cunha, D.A. Savic, *Decision Support for Optimal Design of Water Distribution*

- Networks : A Real Options Approach. 12th International Conference on CCWI2013, pp.1074-1083. (2014)
9. G. Sanz, R. Perez, Demand Pattern Calibration in Water Distribution Networks. 12th International Conference on CCWI2013, pp.1495-1504. (2014)
 10. B. Coelho, A. Andrade-Campos, Efficiency Achievement in Water Supply Systems – A Review. *J. RSER* **30**, 59-84 (2014)
 11. R. Sitzenfrei, M. Moderl, W. Rauch, Automatic Generation of Water Distribution Systems based on GIS Data. *J. ENVSOFT* **47**, 138-147 (2013)